

Compact NSXm

Circuit Breakers, Earth-Leakage Circuit Breakers, and Switch-Disconnectors

User Guide

11/2017



The information provided in this documentation contains general descriptions and/or technical characteristics of the performance of the products contained herein. This documentation is not intended as a substitute for and is not to be used for determining suitability or reliability of these products for specific user applications. It is the duty of any such user or integrator to perform the appropriate and complete risk analysis, evaluation and testing of the products with respect to the relevant specific application or use thereof. Neither Schneider Electric nor any of its affiliates or subsidiaries shall be responsible or liable for misuse of the information contained herein. If you have any suggestions for improvements or amendments or have found errors in this publication, please notify us.

You agree not to reproduce, other than for your own personal, noncommercial use, all or part of this document on any medium whatsoever without permission of Schneider Electric, given in writing. You also agree not to establish any hypertext links to this document or its content. Schneider Electric does not grant any right or license for the personal and noncommercial use of the document or its content, except for a non-exclusive license to consult it on an "as is" basis, at your own risk. All other rights are reserved.

All pertinent state, regional, and local safety regulations must be observed when installing and using this product. For reasons of safety and to help ensure compliance with documented system data, only the manufacturer should perform repairs to components.

When devices are used for applications with technical safety requirements, the relevant instructions must be followed.

Failure to use Schneider Electric software or approved software with our hardware products may result in injury, harm, or improper operating results.

Failure to observe this information can result in injury or equipment damage.

© 2017 Schneider Electric. All Rights Reserved.

Table of Contents



	Safety Information	5
	About the Book	7
Chapter 1	Presentation	9
	Feature Overview	10
	Device Overview	11
	Circuit Breakers: Thermal Magnetic (TM-D) Protection	14
	Earth-Leakage Circuit Breakers: Thermal Magnetic and Earth-Leakage Protections	15
	Switch-Disconnectors	20
	Environmental Conditions	21
Chapter 2	Insulation Requirements and Accessories	25
	Insulation Accessories	26
	Clearance Requirements for Compact NSXm Circuit Breakers	27
Chapter 3	Operation	31
3.1	Operating a Circuit Breaker with a Toggle Handle	32
	Description	33
	Opening, Closing, Resetting, and Testing the Circuit Breaker	34
	Locking the Circuit Breaker	36
3.2	Operating a Circuit Breaker with a Direct Rotary Handle	37
	Description	38
	Opening, Closing, Resetting, and Testing the Circuit Breaker	39
	Locking the Circuit Breaker	42
3.3	Operating a Circuit Breaker with a Front Extended Rotary Handle	45
	Description	46
	Opening, Closing, Resetting, and Testing the Circuit Breaker	47
	Locking the Circuit Breaker	51
3.4	Operating a Circuit Breaker with a Side Rotary Handle	54
	Description	55
	Opening, Closing, Resetting, and Testing the Circuit Breaker	56
	Locking the Circuit Breaker	59
Chapter 4	Electrical Auxiliary Devices	61
	Electrical Auxiliary Devices	62
	Indication Contacts	64
	Voltage Releases	65
	SDx Module	66
Chapter 5	Commissioning and Maintenance	71
	Commissioning the Circuit Breaker	72
	Maintaining the Circuit Breaker During Operation	76
	Responding to a Trip	78
	Troubleshooting	80
Appendices	81
Appendix A	Wiring Diagrams	83
	Circuit Breakers	83
Index	85



Important Information

NOTICE

Read these instructions carefully, and look at the equipment to become familiar with the device before trying to install, operate, service, or maintain it. The following special messages may appear throughout this documentation or on the equipment to warn of potential hazards or to call attention to information that clarifies or simplifies a procedure.



The addition of this symbol to a “Danger” or “Warning” safety label indicates that an electrical hazard exists which will result in personal injury if the instructions are not followed.



This is the safety alert symbol. It is used to alert you to potential personal injury hazards. Obey all safety messages that follow this symbol to avoid possible injury or death.

DANGER

DANGER indicates a hazardous situation which, if not avoided, **will result in** death or serious injury.

WARNING

WARNING indicates a hazardous situation which, if not avoided, **could result in** death or serious injury.

CAUTION

CAUTION indicates a hazardous situation which, if not avoided, **could result in** minor or moderate injury.

NOTICE

NOTICE is used to address practices not related to physical injury.

PLEASE NOTE

Electrical equipment should be installed, operated, serviced, and maintained only by qualified personnel. No responsibility is assumed by Schneider Electric for any consequences arising out of the use of this material.

A qualified person is one who has skills and knowledge related to the construction and operation of electrical equipment and its installation, and has received safety training to recognize and avoid the hazards involved.

About the Book



At a Glance

Document Scope

This guide provides users, installers, and maintenance personnel with technical information needed to operate Compact NSXm circuit breakers in compliance with the IEC/EN, CCC, and EAC standards.

Validity Note

This document applies to Compact NSXm circuit breakers, earth-leakage circuit breakers, and switch-disconnectors.

Convention

In this guide, the term *circuit breaker* refers to circuit breakers, earth-leakage circuit breakers, and switch-disconnectors.

Related Documents

Title of Documentation	Reference Number
Compact NSXm 3P/4P Circuit Breakers - Instruction Sheet	EAV91192
Compact NSXm 3P/4P Earth-Leakage Circuit Breakers - Instruction Sheet	EAV91193
MN/MX Voltage Releases - Instruction Sheet	EAV91202
OF/SD Indication Contacts - Instruction Sheet	EAV91204
SDx Module for Earth-Leakage Circuit Breaker - Instruction Sheet	EAV91206
Connection Accessories - Instruction Sheet	EAV91214
Insulation Accessories - Instruction Sheet	EAV91215
Locking Accessories - Instruction Sheet	NHA56710
Terminal Spreaders - Instruction Sheet	NHA65088
Torque Limiting Breakaway Unit - Instruction Sheet	NHA85013
Interphase Barriers - Instruction Sheet	NHA98087
Open Door Shaft Operator - Instruction Sheet	EAV78496
Direct Rotary Handle - Instruction Sheet	EAV91208
Extended Rotary Handle - Instruction Sheet	EAV91209
Side Rotary Handle - Instruction Sheet	EAV91211

You can download these technical publications and other technical information from our website at <http://www.schneider-electric.com/en/download>

Trademark Notice

All trademarks are owned by Schneider Electric Industries SAS or its affiliated companies.

Chapter 1

Presentation

What Is in This Chapter?

This chapter contains the following topics:

Topic	Page
Feature Overview	10
Device Overview	11
Circuit Breakers: Thermal Magnetic (TM-D) Protection	14
Earth-Leakage Circuit Breakers: Thermal Magnetic and Earth-Leakage Protections	15
Switch-Disconnectors	20
Environmental Conditions	21

Feature Overview

Feature Overview

Compact NSXm devices have the following features:

- Circuit breakers rated from 16 to 160 A
- Available constructions: 3 and 4 poles
- Standard compliance to IEC/EN 60947-2 (circuit breakers and earth-leakage circuit breakers) and IEC/EN 60947-3 (switch-disconnectors)
- Breaking capacities: 16, 25, 36, 50, 70 kA at 415 Vac
- Voltage up to 440 Vac for earth-leakage circuit breakers (compliance to IEC/EN 60947-2)
- Voltage up to 690 Vac for circuit breakers (compliance to IEC/EN 60947-2) and switch-disconnectors (compliance to IEC/EN 60947-3)
- Field installable electrical accessories
- Optional terminations
- Optional operating mechanisms
- Optional voltage releases
- Optional auxiliary contacts
- Optional insulation accessories
- Optional locking accessories

Isolation Characteristics

Circuit breakers offer *positive contact indication* and are suitable for isolation in accordance with standards IEC/EN 60947-2 and IEC/EN 60947-3.

The following markings on the device identification label indicate that the devices are capable of isolation:

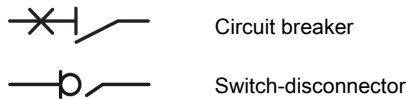

To confirm the isolation capability, the IEC/EN 60947-2 and 3 standards require specific shock withstand tests.

In accordance with installation rules, circuit breakers can be locked in the **O (OFF)** position so that work can be carried out with the power off. Circuit breakers can be locked in the **O (OFF)** position only when they are open.

NOTE: Locking a circuit breaker in the **O (OFF)** position is sufficient to isolate the circuit breaker.

The choice of locking device depends on the type of actuator:

- Locking circuit breakers with a toggle handle ([see page 36](#))
- Locking circuit breakers with a direct rotary handle ([see page 42](#))
- Locking circuit breakers with an extended rotary handle ([see page 51](#))
- Locking circuit breakers with a side rotary handle ([see page 59](#))

Device Overview

Circuit Breaker and Switch-Disconnecter Description

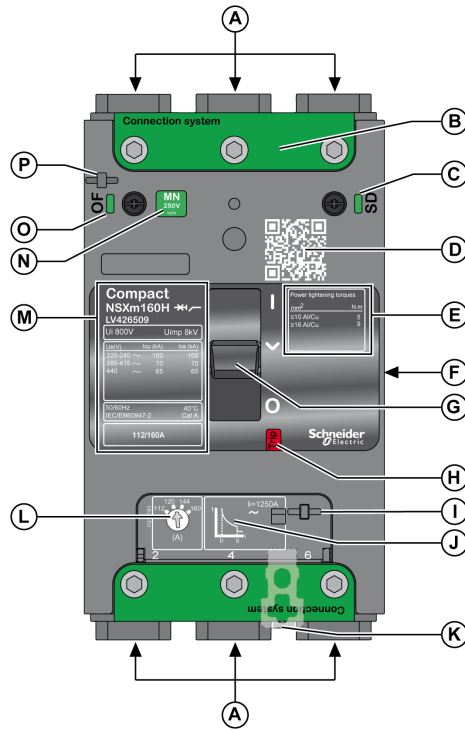

- A Power connection (EverLink™ lug, EverLink lug with control wire terminal, compression lug / busbar, mechanical lug)
- B Connection system cover
- C SD presence indicator
- D QR code to product information
- E Termination information
- F Product and accessory data labels
- G Toggle handle
- H Push-to-trip button
- I Seal for setting cover
- J Tripping curve
- K DIN rail lock
- L Current setting button (for circuit breaker only)
- M Device identification, certification marks, and IEC/EN interrupting ratings
- N MN or MX presence indicator
- O OF presence indicator
- P Seal for accessory cover

Earth-Leakage Circuit Breaker (ELCB) Description

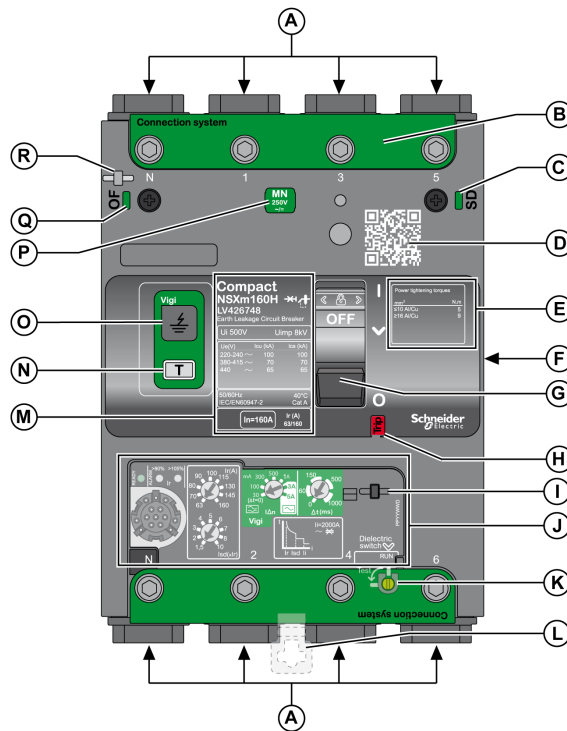

- A Power connection (EverLink™ lug, EverLink lug with control wire terminal, compression lug / busbar, mechanical lug)
- B Connection system cover
- C SD presence indicator
- D QR code to product information
- E Termination information
- F Product and accessory data labels
- G Toggle handle
- H Push-to-trip button
- I Seal for setting cover
- J Trip unit
- K Switch to isolate the device during dielectric tests
- L DIN rail lock
- M Device identification, certification marks, and IEC/EN interrupting ratings
- N Test button of earth-leakage protection
- O Earth-leakage trip indication
- P MN or MX presence indicator
- Q OF presence indicator
- R Seal for accessory cover

The trip unit is described in a specific topic ([see page 15](#)).

QR Code

Scan the QR code to get additional information about the circuit breaker from the Schneider Electric web site. To scan the QR code, use a smartphone that is equipped with a camera and installed with a QR code reader.

Accessories

The following accessories are available for the circuit breaker.

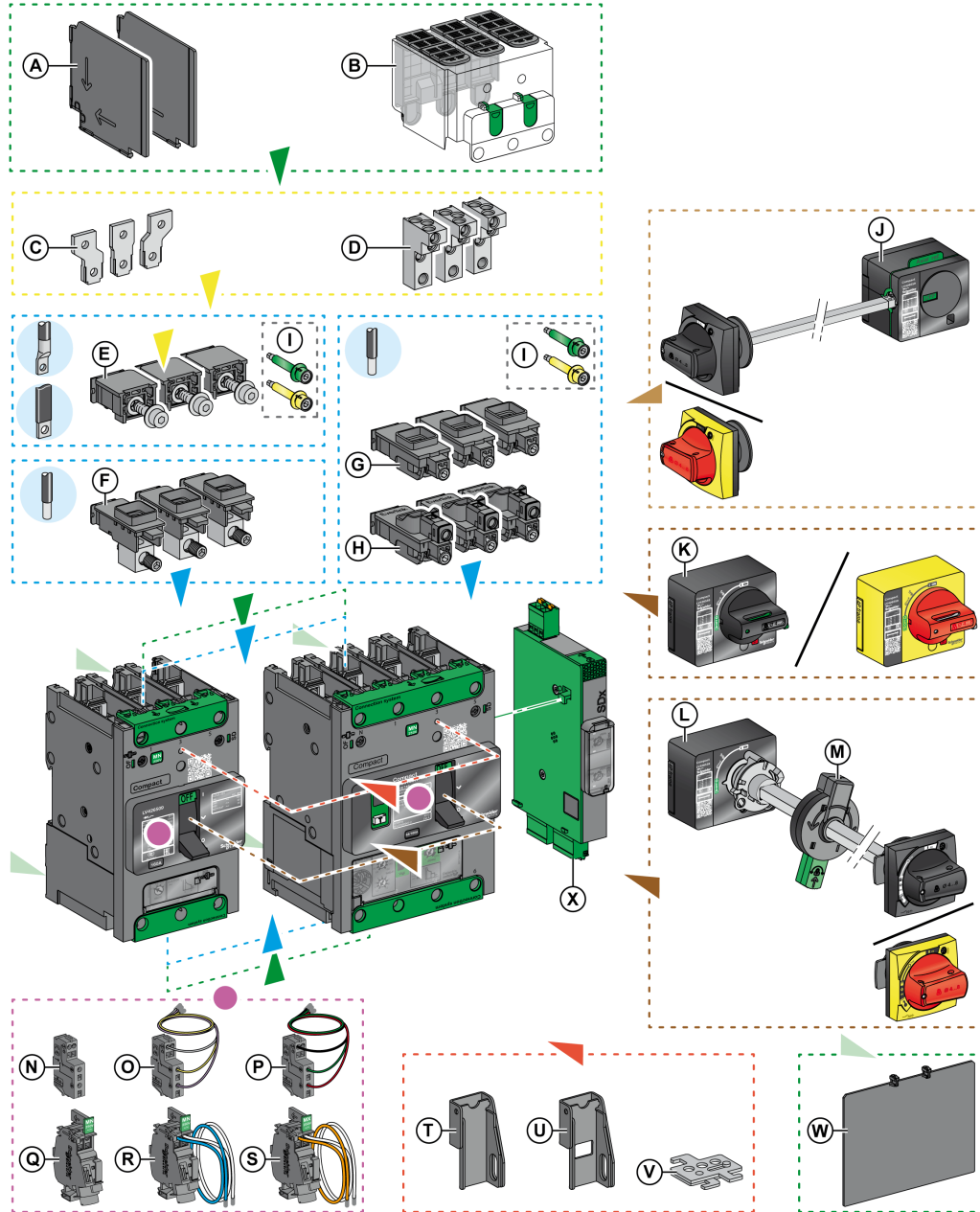

- | | |
|---|---|
| <ul style="list-style-type: none"> A Interphase barriers B Long terminal shield C Terminal spreaders D Power distribution connectors (3-hole or 6-hole) E Compression lug / busbar connector F Aluminum mechanical lug G EverLink lug without control wire terminal H EverLink lug with control wire terminal I Torque limiting breakaway bits J Side rotary handle (right or left) K Direct mounted rotary handle L Extended rotary handle | <ul style="list-style-type: none"> M Open door shaft operator N OF or SD auxiliary contact O OF auxiliary contact pre-wired P SD auxiliary contact pre-wired Q MN or MX voltage release R MN undervoltage release pre-wired S MX shunt trip pre-wired T Fixed toggle handle padlocking device (OFF only) U Fixed toggle handle padlocking device (OFF and ON) V Removable toggle handle padlocking device (OFF only) W Rear insulating screen X SDx module (for earth-leakage circuit breaker only) |
|---|---|

Sealing Accessories

The following sealing accessories can help prevent unauthorized changes to the circuit breaker.

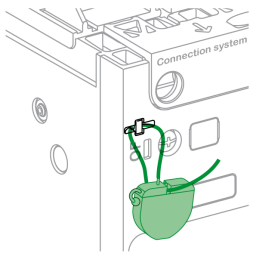
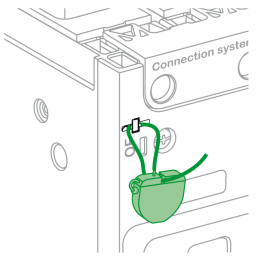
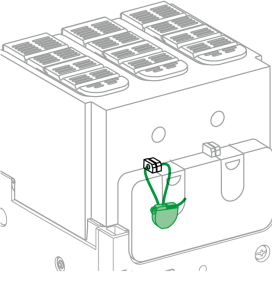
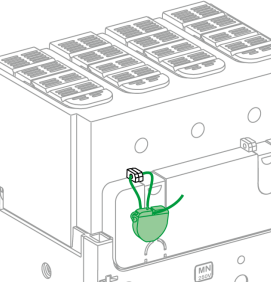
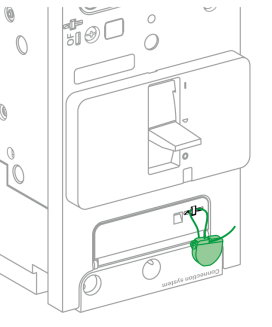
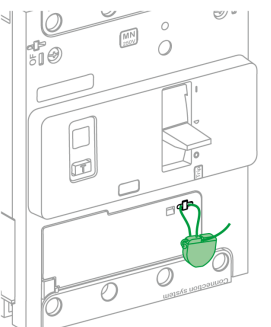
Seal type	Helps to prevent	Seal image for circuit breaker	Seal image for earth-leakage circuit breaker
Seal for cover	<ul style="list-style-type: none"> • Removal of the front cover • Access to the auxiliaries 		
Seal for long terminal shield	<ul style="list-style-type: none"> • Access to the power connections (helps to prevent direct contact) • Dismounting of the circuit breaker 		
Seal for settings	<ul style="list-style-type: none"> • Access to settings 		

Circuit Breakers: Thermal Magnetic (TM-D) Protection

Introduction

Circuit breakers equipped with thermal-magnetic trip units are used for protection of cables on distribution systems supplied by transformers.

Thermal-magnetic trip units provide:

- Thermal protection against overload with an adjustable pickup I_r , and a non-adjustable time-delay.
- Magnetic protection against short circuits, with a fixed pickup I_i .

The following figure shows the tripping curve.

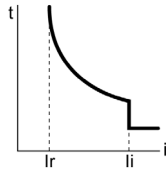

- I_r Thermal protection pickup
- I_i Instantaneous pickup

Thermal Protection (I_r)

The thermal protection pickup I_r is set by using a setting dial.

Turning the thermal protection adjustment dial (A) modifies the tripping curve (B), as shown.

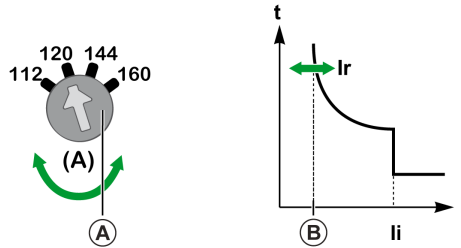

The values of I_r are adjustable from 0.7 to 1 x I_n (circuit breaker rating) as shown in the following table:

Thermal protection		Circuit breaker rating I_n (A)									
		16	25	32	40	50	63	80	100	125	160
Pickup trip between 1.05 and 1.30 x I_r	I_r (A)	Adjustable in amps from 0.7 to 1 x I_n									
Time delay (s)	t_r (s)	Non-adjustable									

Magnetic Protection (I_i)

The instantaneous pickup value I_i cannot be adjusted. Its value for each circuit breaker rating is shown in the following table:

Magnetic protection		Circuit breaker rating I_n (A)									
		16	25	32	40	50	63	80	100	125	160
Pickup $\pm 20\%$	I_i (A)	500	600	600	600	600	800	1000	1250	1250	1250

The time delay for magnetic protection cannot be adjusted:

- Non-tripping time: 10 ms
- Maximum breaking time: 200 ms for $I > 1.5 I_i$

Earth-Leakage Circuit Breakers: Thermal Magnetic and Earth-Leakage Protections

Introduction

Earth-leakage circuit breakers provide the following protection functions:

- Long time protection against overload with an adjustable pickup I_r , and a non-adjustable time delay t_r .
- Short-time protection against short-circuits, with an adjustable pickup I_{sd} , and a non-adjustable time delay t_{sd} .
- Instantaneous protection against short-circuits, with a fixed pickup I_i .
- Neutral protection against overload and short-circuits.
- Earth-leakage protection, against low intensity residual current, with an adjustable pickup $I_{\Delta n}$, and an adjustable time delay Δt .

The following figures show the tripping curves:



Trip Unit Description

The adjustment dials and indications are on the front face of the trip unit or are accessible after opening protective covers.

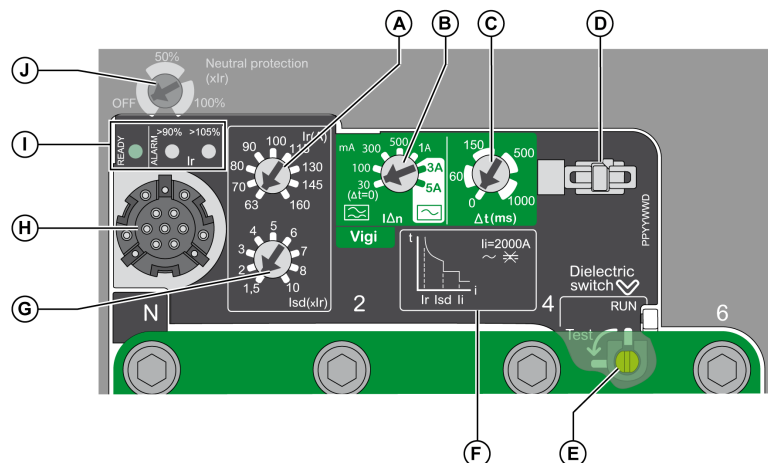

- A** Long-time protection pickup setting (I_r)
- B** Earth-leakage protection pickup setting ($I_{\Delta n}$)
- C** Earth-leakage protection time delay setting (Δt)
- D** Seal for setting cover
- E** Switch to isolate the device during dielectric tests
- F** Tripping curve and instantaneous pickup (I_i)
- G** Short-time protection pickup setting (I_{sd})
- H** Test port
- I** Indication LEDs
- J** Neutral protection setting (4P device only)

Indication LEDs



Indication LEDs on the front of the trip unit indicate its operational state.

Indication LED	Description
Green READY LED	Flashes slowly when the circuit breaker is ready to trip in the event of an overload or short-circuit.
Orange overload pre-alarm LED	Shows a steady light when the load exceeds 90% of the I_r setting.
Red overload alarm LED	Shows a steady light when the load exceeds 105% of the I_r setting.

Setting the Long Time Protection

The long time protection pickup I_r is set by using a multi-position dial.

The long time protection tripping range is 1.05–1.20 I_r according to standard IEC/EN 60947-2.

Rating I_n (A)	Preset values of I_r (A) depending on the rating I_n and the dial position								
25	10	11	12	14	16	18	20	22	25
50	20	22	25	28	32	36	40	45	50
100	40	45	50	56	63	70	80	90	100
160	63	70	80	90	100	115	130	145	160

The time delay t_r for long time protection cannot be adjusted.

The following table shows the value of the time delay t_r for long time protection (in seconds) according to the overload current (in multiples of I_r).

at 1.5 I_r	at 6 I_r	at 7.2 I_r
$t_r = 200$ s	$t_r = 8$ s	$t_r = 5$ s

The accuracy range is -20%/+0%.

Thermal Memory

The trip unit incorporates the thermal memory function which ensures that the conductors are cooled even after tripping. Cooling lasts for 20 minutes before or after tripping.

Setting the Short-Time Protection

The short-time protection pickup I_{sd} is set by using a multi-position dial.

The setting value is expressed in multiples of I_r .

Step	Action
1	Set the long time protection first: the setting pickup is I_r .
2	Turn the I_{sd} adjustment dial to the value required. The I_{sd} value is adjustable from 1.5 I_r to 10 I_r .
3	$I_{sd} = I_{sd}$ setting $\times I_r$.

The accuracy range is +/-15%.

The time delay t_{sd} for short-time protection cannot be adjusted:

- Non-tripping time: 20 ms
- Maximum breaking time: 80 ms

Example of Setting the Short-Time Protection

Setting the short-time protection pickup I_{sd} to 500 A on an earth-leakage circuit breaker rated (I_n) 160 A (see diagram below).

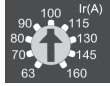
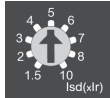
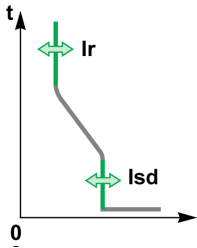
Step	Action	
1	The setting pickup I_r for long time protection is equal to 100 A.	
2	Setting calculation: $I_{sd}/I_r = 500/100 = 5$ Position the I_{sd} adjustment dial on setting 5.	
3	I_{sd} is set to $5 \times 100 \text{ A} (= 500 \text{ A})$.	

Setting the Instantaneous Protection

The pickup I_i and time delay for instantaneous protection cannot be adjusted.

The following table shows the value of the pickup I_i (in amperes) and time delay (in milliseconds) for instantaneous protection according to the rating I_n :

Rating I_n (A)	25	50	100	160
Pickup I_i (A)	375	750	1500	2000
Non-tripping time (ms)	10	10	10	5

The accuracy range of pickup is $\pm 15\%$.

The maximum breaking time is 50 ms for $I > 1.5 I_i$

Setting the Neutral Protection (4P Only)

The neutral selection dial gives a choice of two or three values for the neutral long time and short-time protection pickups.

NOTE: To access the neutral selection dial, open the ELCB accessory cover by unscrewing the two front screws.

The following table shows the values of the pickup for neutral long time protection (in multiples of I_r) and neutral short-time protection (in multiples of I_{sd}) according to the dial position:

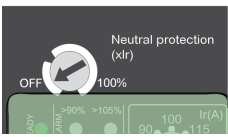
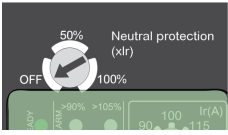
Rating I_n (A)	Dial	Setting	Long-time setting value	Short-time setting value
25–50		OFF (4P 3D)	–	–
		100% (4P 4D)	I_r	I_{sd}
100–160		OFF (4P 3D)	–	–
		50% (4P 3D + N/2)	$I_r/2$	$I_{sd}/2$
		100% (4P 4D)	I_r	I_{sd}

The time delay for the neutral long time protection and short-time protection is the same as that for the phases.

Operating Principle of Earth-Leakage Protection

Earth-leakage protection is definite time. The earth-leakage protection threshold $I\Delta n$ sets the level of earth-leakage at which the circuit breaker trips when reaching the earth-leakage protection time delay Δt .

Setting the Earth-Leakage Protection

The earth-leakage protection $I\Delta n$ is set by using one multi-position dial.

The following table shows the value of the pickup $I\Delta n$ for earth-leakage protection according to the type defined in IEC/EN 60947-2, Annex B standard:

Earth-leakage type	Pickup $I\Delta n$						
A ⁽¹⁾	30 mA	100 mA	300 mA	500 mA	1 A	–	–
AC ⁽²⁾	30 mA	100 mA	300 mA	500 mA	1 A	3 A	5 A
<p>(1) Residual current circuit breakers which provide additional protection to AC type in that they are sensitive to AC currents and pulsating DC currents. Tripping is ensured for sinusoidal, alternating residual currents as well as for pulsed DC residual currents, whether suddenly applied or slowly arising.</p> <p>(2) Residual current circuit breakers sensitive to AC currents and suitable for most domestic and commercial applications. Tripping is ensured for sinusoidal, alternating currents, whether suddenly applied or slowly arising.</p>							

Setting the Earth-Leakage Protection Time Delay

The time delay of the earth-leakage protection is set by using one multi-position dial.

When $I\Delta n$ is set to **30 mA**, the time delay has a fixed value of $\Delta t = 0$ s (instantaneous tripping).

When $I\Delta n$ is set above **30 mA**, the time delay Δt can be adjusted to the following values:

- 0 ms
- 60 ms
- 150 ms
- 500 ms
- 1 second

Testing the Earth-Leakage Protection

The earth-leakage protection must be tested regularly by using the test button (T). Pressing the test button simulates a real leakage current passing through the toroid, and the device trips.

⚠ CAUTION

HAZARD OF NUISANCE TRIPPING

Circuit breaker tests must only be done by qualified electrical personnel.

Failure to follow these instructions can result in injury or equipment damage.

When testing the earth-leakage protection function, take precautions against:

- Disrupting operations
- Activating inappropriate alarms
- Triggering unwanted actions

Follow these steps to test the earth-leakage protection of an earth-leakage circuit breaker (for example, with a toggle handle).

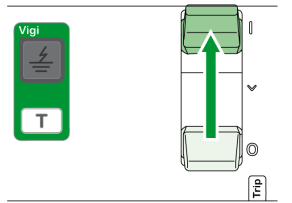
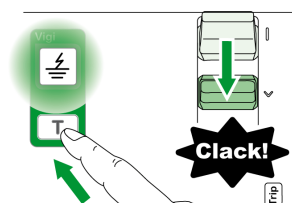
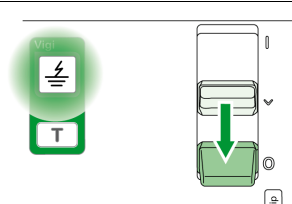
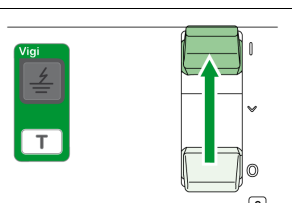
Step	Action	
1	Energize the earth-leakage circuit breaker: $200 \text{ Vac} \leq V_{L-L} \leq 440 \text{ Vac}$.	–
2	Push the toggle handle from the O (OFF) position to the I (ON) position. The circuit breaker is closed.	
3	Press the test button T : the earth-leakage circuit breaker trips and the earth-leakage trip indication lights up. NOTE: If the earth-leakage circuit breaker does not trip: 1. Check that the earth-leakage circuit breaker is energized (see step 1). 2. If the earth-leakage circuit breaker is correctly energized and has not tripped, replace it.	
4	Push the toggle handle from the ✓ (Trip) position to the O (OFF) position. The earth-leakage trip indication: • stays lit if the earth-leakage circuit breaker is energized upstream. • turns off if the earth-leakage circuit breaker is energized downstream.	
5	Push the toggle handle from the O (OFF) position to the I (ON) position. The earth-leakage trip indication turns off (if the earth-leakage circuit breaker is energized upstream). The circuit breaker is closed.	

Switch-Disconnectors

Introduction

A switch-disconnector is a control device that can be used to open and close a circuit under normal operating conditions. The switch-disconnector can make or break its rated current. For an overload or a short-circuit, it must be protected by an upstream device, in compliance with installation standards.

Switch-Disconnecter Utilization Category

Depending on the rated operational current and the mechanical durability (A for frequent operation or B for infrequent operation), standard IEC/EN 60947-3 defines the utilization categories as shown in the following table. Compact NSXm NA switch-disconnectors comply with utilization categories AC-21A or AC-22A up to 160 A and AC-23A up to 100 A.

Utilization categories		
Infrequent operation	Frequent operation	Characteristics
AC-21B	AC-21A	Switching of resistive loads including moderate overloads ($\cos \varphi = 0.95$)
AC-22B	AC-22A	Switching of mixed resistive and inductive loads, including moderate overloads ($\cos \varphi = 0.65$)
AC-23B	AC-23A	Switching of motor loads or other highly inductive loads ($\cos \varphi = 0.45$ or 0.35)

Environmental Conditions

Temperature

The following temperatures are relevant for circuit breakers:

- **Ambient temperature:** the temperature of the air immediately surrounding the circuit breaker. If the temperature inside the enclosure is above 40 °C (104 °F), devices must be derated.
- **Operating temperature range:**
 - Circuit breaker: -25 °C to +70 °C (-13 °F to +158 °F).
NOTE: Commissioning is possible down to -35 °C (-31 °F).
 - Earth-leakage circuit breaker: -25 °C to +70 °C (-13 °F to +158 °F).
NOTE: The earth-leakage trip indication may not work below -15 °C (5 °F).
- **Storage temperature range (in original packing):** -50 °C to +85 °C (-58 °F to +185 °F).

Temperature Derating for Earth-Leakage Circuit Breaker

Above the reference temperature of 40 °C (104 °F), the ampere ratings for the earth-leakage circuit breaker are given in the following derating table:

Circuit breaker rating In (A)	Temperature						
	40 °C (104 °F)	45 °C (113 °F)	50 °C (122 °F)	55 °C (131 °F)	60 °C (140 °F)	65 °C (149 °F)	70 °C (158 °F)
25	25	25	25	25	25	25	25
50	50	50	50	50	50	50	50
100	100	100	100	100	100	100	100
160	160	155	150	145	140	135	130

Temperature Derating for Thermal-Magnetic (TM-D) Circuit Breaker

Above the reference temperature of 40 °C (104 °F), the ampere ratings for the circuit breaker are given in the following derating table:

Circuit breaker rating In (A)	Temperature						
	40 °C (104 °F)	45 °C (113 °F)	50 °C (122 °F)	55 °C (131 °F)	60 °C (140 °F)	65 °C (149 °F)	70 °C (158 °F)
16	16	16	15	15	14	14	13
25	25	24	24	23	23	22	21
32	32	31	30	30	29	28	27
40	40	39	38	37	36	34	33
50	50	49	48	46	45	44	42
63	63	61	60	58	56	54	53
80	80	77	73	70	67	64	60
100	100	96	94	90	87	83	80
125	125	120	117	113	109	104	100
160	160	155	149	144	139	133	126

Correction Factor for Thermal-Magnetic (TM-D) Circuit Breaker Tripping Time

The overload protection is calibrated at 40 °C (104 °F) in the lab. This means that when the ambient temperature is below or above 40 °C (104 °F), the Ir protection pickup is slightly different.

The following table gives the correction factor that applies to tripping time depending on ambient temperature:

Rating In (A)	Temperature												
	10 °C (50 °F)	15 °C (59 °F)	20 °C (68 °F)	25 °C (77 °F)	30 °C (86 °F)	35 °C (95 °F)	40 °C (104 °F)	45 °C (113 °F)	50 °C (122 °F)	55 °C (131 °F)	60 °C (140 °F)	65 °C (149 °F)	70 °C (158 °F)
16	1.16	1.13	1.11	1.08	1.05	1.03	1.00	0.97	0.94	0.91	0.88	0.85	0.81
25	1.13	1.11	1.09	1.07	1.05	1.02	1.00	0.98	0.95	0.93	0.90	0.88	0.85
32	1.14	1.11	1.09	1.07	1.05	1.02	1.00	0.98	0.95	0.93	0.90	0.87	0.84
40	1.15	1.12	1.10	1.08	1.05	1.03	1.00	0.97	0.95	0.92	0.89	0.86	0.83
50	1.13	1.11	1.09	1.07	1.05	1.02	1.00	0.98	0.95	0.93	0.90	0.87	0.85
63	1.14	1.12	1.10	1.07	1.05	1.02	1.00	0.97	0.95	0.92	0.89	0.86	0.83
80	1.21	1.18	1.14	1.11	1.07	1.04	1.00	0.96	0.92	0.88	0.83	0.80	0.75
100	1.18	1.16	1.12	1.10	1.06	1.04	1.00	0.96	0.94	0.90	0.87	0.83	0.80
125	1.17	1.14	1.11	1.08	1.06	1.03	1.00	0.96	0.93	0.90	0.87	0.84	0.80
160	1.17	1.15	1.12	1.09	1.06	1.03	1.00	0.97	0.93	0.90	0.87	0.83	0.79

Extreme Atmospheric Conditions

Circuit breakers and earth-leakage circuit breakers are designed to operate in industrial atmospheres as defined in standard IEC/EN 60947-2 and IEC/EN 60664-1 for the highest level of pollution (level 3).

Switch-disconnectors are designed to operate in industrial atmospheres as defined in standard IEC/EN 60947-3 and IEC/EN 60664-1 for the highest level of pollution (level 3).

Circuit breakers are tested for extreme storage conditions and are compliant with the following standards:

Standard	Title
IEC/EN 60068-2-2	Dry heat, severity level +85 °C (+185 °F)
IEC/EN 60068-2-1	Dry cold, severity level -50 °C (-58 °F) (circuit breaker only)
IEC/EN 60068-2-30	Damp heat: <ul style="list-style-type: none"> • Temperature +55 °C (+131 °F) • Relative humidity 95%
IEC/EN 60068-2-52	Salt-mist, severity 2

To maximize lifetime, install circuit breakers in properly ventilated equipment with minimal dust.

Vibration

Circuit breakers are designed to withstand vibration. They meet the IEC/EN 60068-2-6 standard for vibration:

- 2 Hz to 13.2 Hz with an amplitude of +/- 1 mm (+/- 0.04 in.)
- 13.2 Hz to 100 Hz at a constant acceleration of +/- 0.7 g

Conformity tests are carried out in accordance with the IEC/EN 60068-2-6 standard, at the levels of severity required by the merchant shipping regulatory bodies (mainly IACS, Veritas, and Lloyds).

Excessive vibration can cause tripping, breaks in connections, or damage to mechanical parts.

Electromagnetic Disturbance

Circuit breakers resist electromagnetic disturbance. They comply with the requirements of the electromagnetic compatibility (EMC) standard IEC/EN 60947-2.

Altitude

Circuit breakers are designed to operate within specification at altitudes up to 2,000 m (6,600 ft.). Above 2,000 m (6,600 ft), the following derating is required:

Characteristic		Altitude (m/ft)			
		2,000 m (6,600 ft)	3,000 m (9,800 ft)	4,000 m (13,000 ft)	5,000 m (16,500 ft)
Impulse withstand voltage	U _{imp}	8 kV	7.1 kV	6.4 kV	5.6 kV
Insulation voltage for circuit breaker	U _i	800 V	710 V	635 V	560 V
Insulation voltage for earth-leakage circuit breaker	U _i	500 V	445 V	400 V	350 V
Maximum operational voltage for circuit breaker	U _e	690 V	690 V	635 V	560 V
Maximum operational voltage for earth-leakage circuit breaker	U _e	440 V	440 V	400 V	350 V
Average current capacity (A) at 40 °C (104 °F)	I _{n x}	1	0.98	0.96	0.94

Chapter 2

Insulation Requirements and Accessories

What Is in This Chapter?

This chapter contains the following topics:

Topic	Page
Insulation Accessories	26
Clearance Requirements for Compact NSXm Circuit Breakers	27

Insulation Accessories

Overview of Insulation Accessories

The following insulation accessories can be used with the range of Compact NSXm circuit breakers. For more information, see the *Compact NSXm Catalog*.

Insulation accessory	All power connectors	
	3P	4P
Long terminal shield	✓	✓
Interphase barriers	✓	✓
Rear insulation screen	✓	✓

Presentation of Insulation Accessories

The following insulation accessories can be installed on-site.

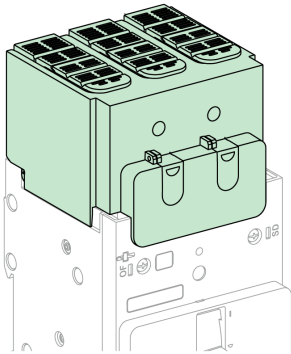
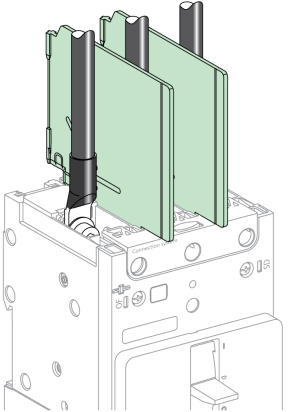
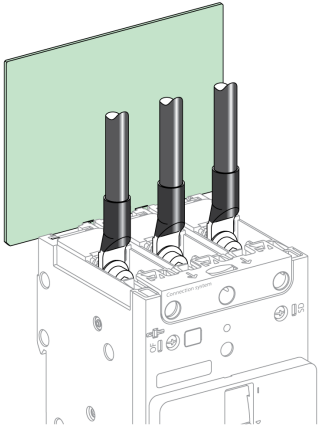
Insulation accessory	Benefit	Accessory image
Long terminal shield	IP40 protection	
Flexible interphase barriers	Improve insulation between power connections	
Rear insulation screen	Improve insulation between backplate and power connections, especially with spreaders	

Clearance Requirements for Compact NSXm Circuit Breakers

Introduction

When installing Compact NSXm circuit breakers in equipment, minimum distances (safety clearance) must be maintained between the device and panels, bars, or any metal installed nearby.

Minimum distances depend on the ultimate breaking capacity, and are defined by tests carried out in accordance with the IEC/EN 60947-2 standard.

If IEC/EN installation conformity is not checked by type tests, you must also:

- Use insulated bars for circuit breaker connections.
- Block off the busbars by using rear insulation screens.

Equipment Installation Requirements

 **DANGER**

HAZARD OF ELECTRIC SHOCK, EXPLOSION, OR ARC FLASH

- Apply appropriate personal protective equipment (PPE) and follow safe electrical work practices. See NFPA 70E, CSA Z462, NOM-029-STPS, or local equivalent.
- This equipment must only be installed and serviced by qualified electrical personnel.
- Turn off all power supplying this equipment before working on or inside equipment.
- Always use a properly rated voltage sensing device to confirm that power is off.
- Replace all devices, doors, and covers before turning on power to this equipment.
- Beware of potential hazards, and carefully inspect the work area for tools and objects that may have been left inside the equipment.

Failure to follow these instructions will result in death or serious injury.

Follow these guidelines when installing circuit breakers in equipment:

- Respect minimum distances.
- Perform dielectric strength tests, thermal calculations, and temperature rise tests as required by the configuration of the installation.
- Respect the limits defined in the derating tables, depending on the ambient temperature (ratings are based on IEC/EN 60947-2 standard).

 **DANGER**

HAZARD OF ELECTRIC SHOCK, EXPLOSION, OR ARC FLASH

Install circuit breaker so minimum clearance distance to grounded metal is maintained.

Failure to follow these instructions will result in death or serious injury.

Minimum Distances for Side-by-Side Installation

There is no minimum distance required between circuit breakers installed side-by-side.

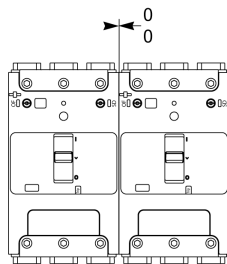

Minimum Clearance Without Insulation Accessories

The minimum clearance distances required around circuit breakers without insulation accessories are shown below.

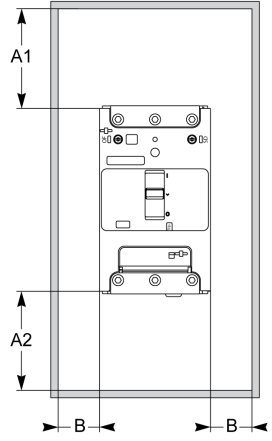
3P/4P	Clearance (Operating voltage ≤690 V)
	<p>With painted sheet metal:</p> <ul style="list-style-type: none"> ● A1: 30 mm (1.18 in.) ● A2: 5 mm (0.19 in.) ● B: 0 mm (0 in.) <p>With bare sheet metal:</p> <ul style="list-style-type: none"> ● A1: 40 mm (1.57 in.) ● A2: 5 mm (0.19 in.) ● B: 5 mm (0.19 in.)

Minimum Clearance with Interphase Barriers

The minimum clearance distances required around circuit breakers equipped with interphase barriers are shown below.

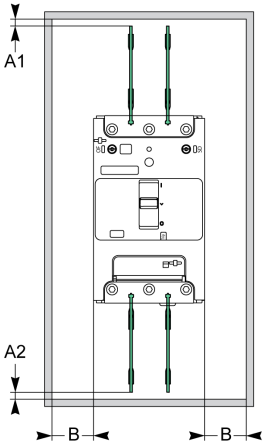
3P/4P	Clearance (Operating voltage ≤690 V)
	<p>With painted sheet metal:</p> <ul style="list-style-type: none"> ● A1: 0 mm (0 in.) ● A2: 0 mm (0 in.) ● B: 0 mm (0 in.) <p>With bare sheet metal:</p> <ul style="list-style-type: none"> ● A1: 0 mm (0 in.) ● A2: 0 mm (0 in.) ● B: 5 mm (0.19 in.)

Minimum Clearance with Long Terminal Shields

The minimum clearance distances required around circuit breakers equipped with long terminal shields are shown below.

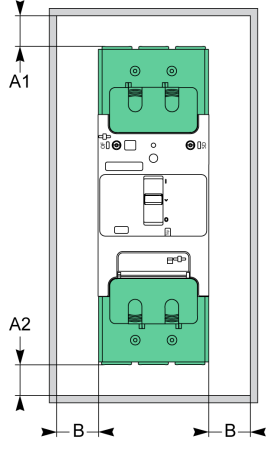
3P/4P	Clearance (Operating voltage ≤690 V)
	<p>With painted sheet metal:</p> <ul style="list-style-type: none"> ● A1: 0 mm (0 in.) ● A2: 0 mm (0 in.) ● B: 0 mm (0 in.) <p>With bare sheet metal:</p> <ul style="list-style-type: none"> ● A1: 0 mm (0 in.) ● A2: 0 mm (0 in.) ● B: 5 mm (0.19 in.)

Minimum Clearance to Bare Busbars

The minimum clearance distances required around circuit breakers that use busbars are shown below.

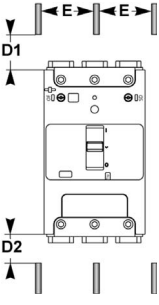
3P/4P	Spacing	Clearance ¹ (Operating voltage ≤690 V)
	E ≤ 60 mm (2.36 in.)	<ul style="list-style-type: none"> ● D1: 200 mm (7.87 in.) ● D2: 100 mm (3.94 in.)
	E > 60 mm (2.36 in.)	<ul style="list-style-type: none"> ● D1: 120 mm (4.72 in.) ● D2: 60 mm (2.36 in.)
<p>¹ These clearances can be reduced for special installations if they are validated with appropriate tests.</p>		

Minimum Clearance Between Backplate and Uninsulated Power Connections

For all types of Compact NSXm circuit breakers that use uninsulated power connections (for example, busbars, spreaders, or uninsulated crimped lugs), the minimum clearance distance with the enclosure backplate is shown below.

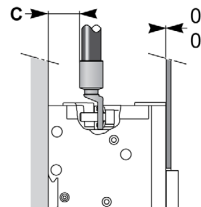

A rear insulation screen or long terminal shield is required if the distance C is less than 8 mm (0.32 in.).

Chapter 3

Operation

What Is in This Chapter?

This chapter contains the following sections:

Section	Topic	Page
3.1	Operating a Circuit Breaker with a Toggle Handle	32
3.2	Operating a Circuit Breaker with a Direct Rotary Handle	37
3.3	Operating a Circuit Breaker with a Front Extended Rotary Handle	45
3.4	Operating a Circuit Breaker with a Side Rotary Handle	54

Section 3.1

Operating a Circuit Breaker with a Toggle Handle

What Is in This Section?

This section contains the following topics:

Topic	Page
Description	33
Opening, Closing, Resetting, and Testing the Circuit Breaker	34
Locking the Circuit Breaker	36

Description

Front Face

The following figure shows the controls and indicators for a 3-pole circuit breaker with a toggle handle. The location of controls and indicators may differ for the other types of circuit breakers. Information about the other parts of the front face is available in the general description (*see page 11*).

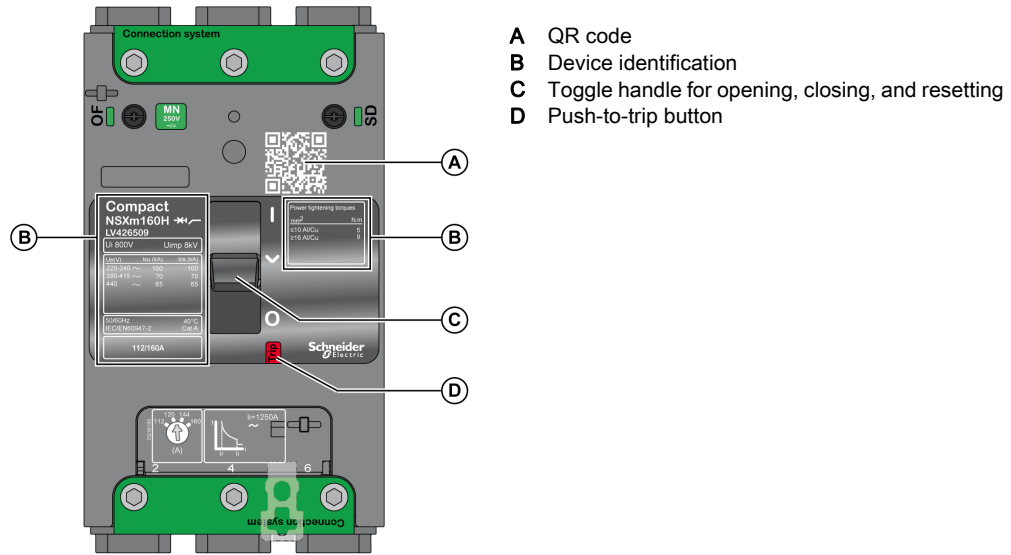

Device Identification

The following figure shows an example of the device identification for a circuit breaker with a toggle handle. Your circuit breaker may have different values.

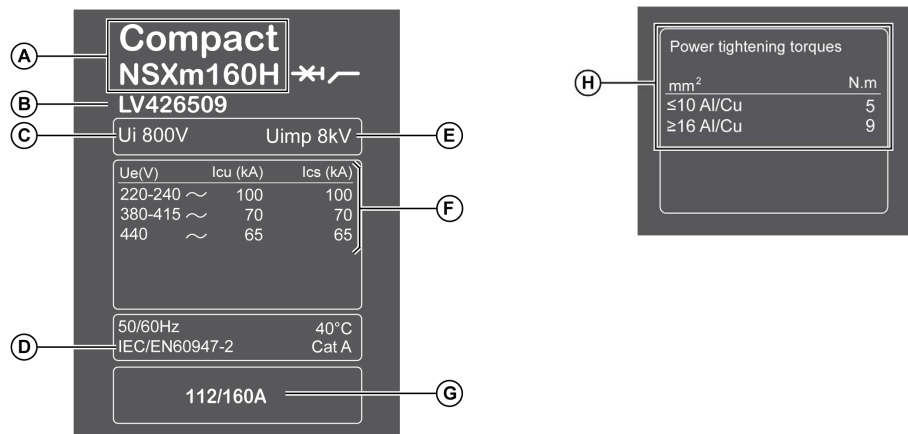

- A** Circuit breaker type:
 - Range name (Compact NSXm)
 - Circuit breaker rating In (160)
 - Performance level (H)
- B** Commercial reference
- C** **Ui**: rated insulation voltage
- D** IEC/EN reference standard
- E** **Uimp** rated impulse withstand voltage
- F** IEC/EN interrupting ratings, according to operating voltage Ue:
Icu: Ultimate breaking capacity
Ics: Service breaking capacity
- G** Protection setting range.
 The circuit breaker rating In corresponds to the maximum value.
- H** Power connection tightening torques

QR Code

Scan the QR code to get additional information about the circuit breaker from the Schneider Electric website. To scan the QR code, use a smartphone that is equipped with a camera and installed with a QR code reader.

Opening, Closing, Resetting, and Testing the Circuit Breaker

Opening and Closing with the Toggle Handle

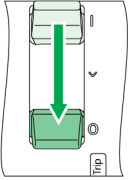
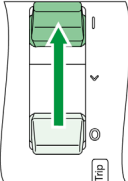
Task	Action	
Open the circuit breaker	Push the toggle handle from the I (ON) position to the O (OFF) position.	
Close the circuit breaker	Push the toggle handle from the O (OFF) position to the I (ON) position	

Resetting with the Toggle Handle After a Trip

When the circuit breaker trips, the toggle handle moves from the **I (ON)** position to the **∨ (Trip)** position.

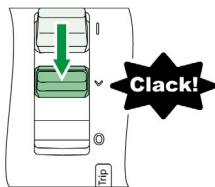

<p>⚠ WARNING</p> <p>HAZARD OF CLOSING ON ELECTRICAL FAULT</p> <p>Do not close the circuit breaker again without first inspecting and, if necessary, repairing the downstream electrical equipment.</p> <p>Failure to follow these instructions can result in death, serious injury, or equipment damage.</p>

The fact that a circuit breaker has tripped does not fix the cause of the fault detected on the downstream electrical equipment.

Follow these steps to reset the circuit breaker after a trip caused by an electrical fault.

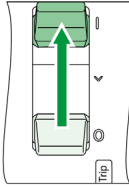
Step	Action		Position
1	Push the toggle handle from the ▼ (Trip) position to the O (OFF) position. The circuit breaker is open.		O (OFF)
2	Take precautions to protect yourself <i>(see page 78)</i> .	–	O (OFF)
3	Look for the cause of the detected fault <i>(see page 78)</i> .	–	O (OFF)
4	Clean and test the downstream equipment and the circuit breaker <i>(see page 78)</i> .	–	O (OFF)
5	Push the toggle handle from the O (OFF) position to the I (ON) position. The circuit breaker is closed.		I (ON)

Testing the Trip Mechanism

⚠ CAUTION
HAZARD OF NUISANCE TRIPPING
Circuit breaker tests must only be done by qualified electrical personnel.
Failure to follow these instructions can result in injury or equipment damage.

When testing the trip mechanism, take precautions against:

- Disrupting operations
- Activating inappropriate alarms
- Triggering unwanted actions

For example, tripping the circuit breaker with the push-to-trip button can lead to inappropriate fault indications or corrective actions (such as switching to an alternate power source).

Follow these steps to test the trip mechanism.

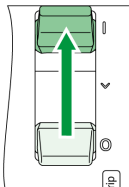
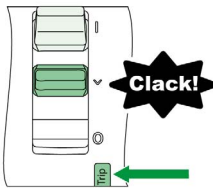
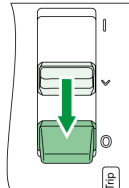
Step	Action		Position
1	Push the toggle handle from the O (OFF) position to the I (ON) position. The circuit breaker is closed.		I (ON)
2	Press the push-to-trip button. The handle moves from the I (ON) position to the ▼ (Trip) position. The circuit breaker is tripped.		▼ (Trip)
3	Push the toggle handle from the ▼ (Trip) position to the O (OFF) position. The circuit breaker is reset.		O (OFF)

Locking the Circuit Breaker

Locking Options for the Toggle Handle

⚡ ⚠ DANGER

HAZARD OF ELECTRIC SHOCK, EXPLOSION, OR ARC FLASH

When the circuit breaker handle is locked in the **OFF (O)** position, always use a properly rated voltage sensing device to confirm that power is off before working on equipment.

Failure to follow these instructions will result in death or serious injury.

NOTE: Locking the handle in the **I (ON)** position does not disable the circuit breaker. If an electrical fault is detected, the circuit breaker trips. When the handle is unlocked, it moves to the tripped position. To return the circuit breaker to service, reset the circuit breaker (*see page 34*).

The following accessories can be used to lock the toggle handle:

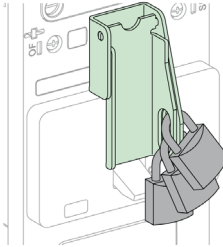
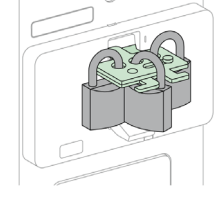
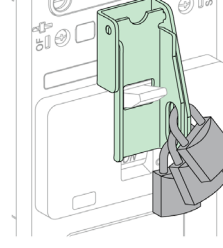
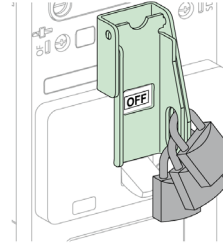
Locked position	Lock type	Lock characteristics	Lock image
O (OFF)	Fixed: the device cannot be removed from the case.	Up to 3 padlocks (not supplied) Diameter 4–8 mm (3/16–5/16 in.)	
O (OFF)	Removable: the device can be removed from the case.	Up to 3 padlocks (not supplied) Diameter 4–8 mm (3/16–5/16 in.)	
I (ON) or O (OFF)	Fixed: the device cannot be removed from the case.	Up to 3 padlocks (not supplied) Diameter 4–8 mm (3/16–5/16 in.)	Locked in the I (ON) position. 
			Locked in the O (OFF) position. 

Section 3.2

Operating a Circuit Breaker with a Direct Rotary Handle

What Is in This Section?

This section contains the following topics:

Topic	Page
Description	38
Opening, Closing, Resetting, and Testing the Circuit Breaker	39
Locking the Circuit Breaker	42

Description

Front Face

The following figure shows the controls and indicators for a 3-pole circuit breaker with a direct rotary handle. The location of controls and indicators may differ for the other types of circuit breakers. Information about the other parts of the front face is available in the general description (*see page 11*).

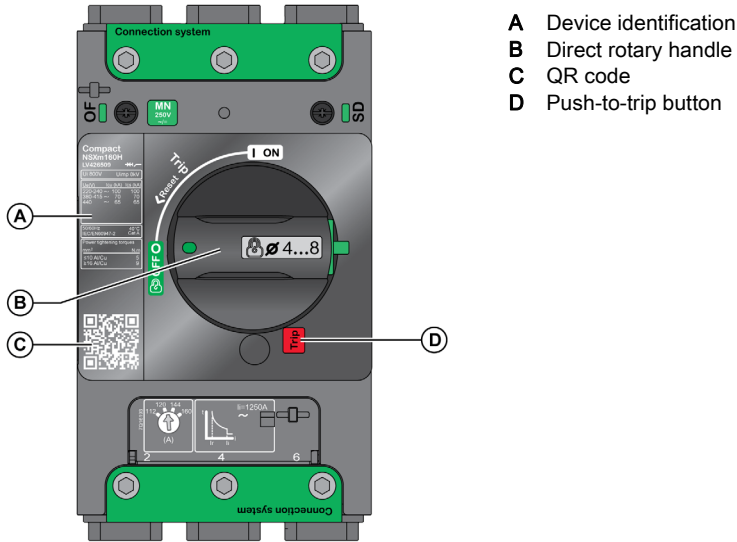

- A Device identification
- B Direct rotary handle
- C QR code
- D Push-to-trip button

Device Identification

The following figure shows an example of the device identification for a circuit breaker with a direct rotary handle. Your circuit breaker may have different values.

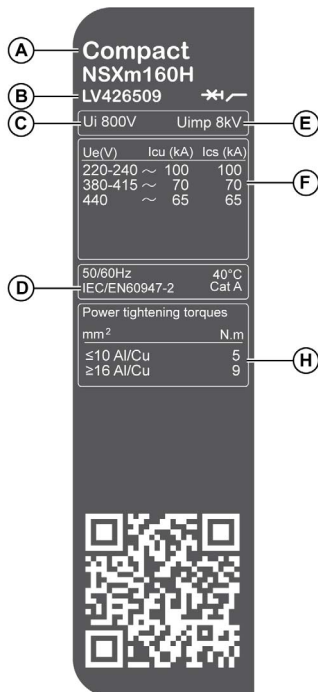

- A Circuit breaker type:
 - Range name (Compact NSXm)
 - Circuit breaker rating In (160)
 - Performance level (H)
- B Commercial reference
- C **Ui**: rated insulation voltage
- D IEC/EN reference standard
- E **Uimp** rated impulse withstand voltage
- F IEC/EN interrupting ratings, according to operating voltage **Ue**:
 - Icu**: Ultimate breaking capacity
 - Ics**: Service breaking capacity
- H Power connection tightening torques

QR Code

Scan the QR code to get additional information about the circuit breaker from the Schneider Electric website. To scan the QR code, use a smartphone that is equipped with a camera and installed with a QR code reader.

Opening, Closing, Resetting, and Testing the Circuit Breaker

Opening and Closing with the Direct Rotary Handle

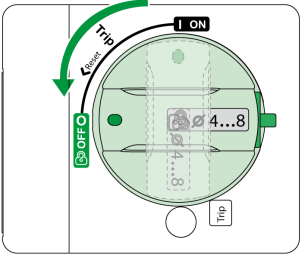
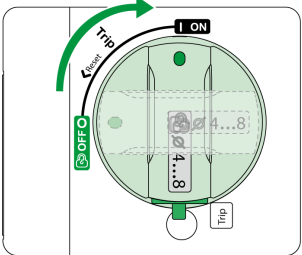
Task	Action	
Open the circuit breaker	Turn the rotary handle from the I (ON) position to the O (OFF) position.	
Close the circuit breaker	Turn the rotary handle from the O (OFF) position to the I (ON) position.	

Resetting with the Direct Rotary Handle After a Trip

When the circuit breaker trips, the rotary handle moves from the **I (ON)** position to the **Trip** position.

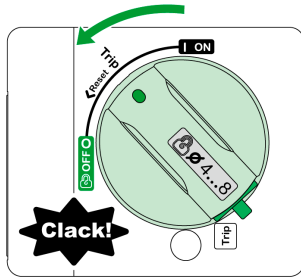

⚠ WARNING
HAZARD OF CLOSING ON ELECTRICAL FAULT
Do not close the circuit breaker again without first inspecting and, if necessary, repairing the downstream electrical equipment.
Failure to follow these instructions can result in death, serious injury, or equipment damage.

The fact that a circuit breaker has tripped does not fix the cause of the fault detected on the downstream electrical equipment.

Follow these steps to reset the circuit breaker after a trip caused by an electrical fault.

Step	Action	Position
1	Turn the rotary handle from the Trip position to the O (OFF) position. The circuit breaker resets and is open.	O (OFF)
2	Take precautions to protect yourself (<i>see page 78</i>).	O (OFF)
3	Look for the cause of the detected fault (<i>see page 78</i>).	O (OFF)
4	Clean and test the downstream equipment and the circuit breaker (<i>see page 78</i>).	O (OFF)
5	Turn the rotary handle from the O (OFF) position to the I (ON) position. The circuit breaker is closed.	I (ON)

Testing the Trip Mechanism

⚠ CAUTION

HAZARD OF NUISANCE TRIPPING
 Circuit breaker tests must only be done by qualified electrical personnel.
Failure to follow these instructions can result in injury or equipment damage.

When testing the trip mechanism, take precautions against:

- Disrupting operations
- Activating inappropriate alarms
- Triggering unwanted actions

For example, tripping the circuit breaker with the push-to-trip button can lead to inappropriate fault indications or corrective actions (such as switching to an alternate power source).

Follow these steps to test the trip mechanism.

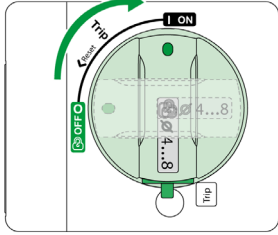
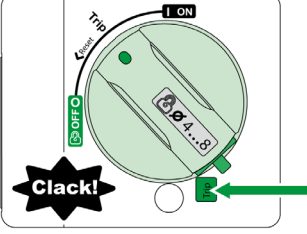
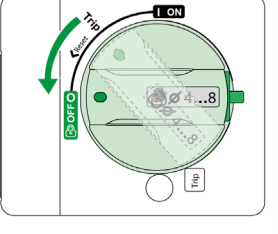
Step	Action		Position
1	Turn the rotary handle from the O (OFF) position to the I (ON) position. The circuit breaker is closed.		I (ON)
2	Press the Trip button. The handle moves from the I (ON) position to the Trip position. The circuit breaker is tripped.		Trip
3	Turn the rotary handle from the Trip position to the O (OFF) position. The circuit breaker is reset.		O (OFF)

Locking the Circuit Breaker

Locking Options with the Direct Rotary Handle

⚡ ⚠ **DANGER**

HAZARD OF ELECTRIC SHOCK, EXPLOSION, OR ARC FLASH

When the circuit breaker handle is locked in the **OFF (O)** position, always use a properly rated voltage sensing device to confirm that power is off before working on equipment.

Failure to follow these instructions will result in death or serious injury.

The direct rotary handle offers the following locking options:

- Prevent the door from being opened if the door interlock was activated at installation time
- Prevent the rotary handle from being operated

The handle can be locked in the **O (OFF)** or **I (ON)** position.

No setup is required to lock the handle in the **O (OFF)** position.

Before the handle can be locked in the **I (ON)** position, the rotary handle block must be dismantled and the physical setup of the handle must be changed. This is usually done at installation. For information about how to set up the handle to be locked in the **I (ON)** position, see the relevant instruction sheet ([see page 7](#)).

NOTE: Locking the rotary handle in the **I (ON)** position does not disable the circuit breaker. If an electrical fault is detected, the circuit breaker still trips. When the rotary handle is unlocked, it moves to the **Trip** position.

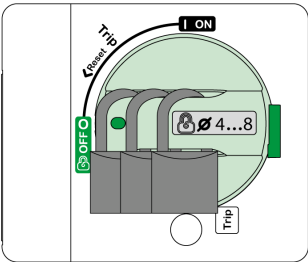
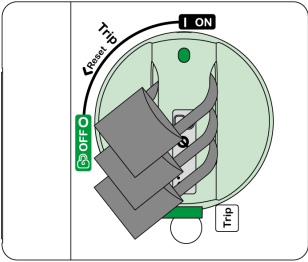
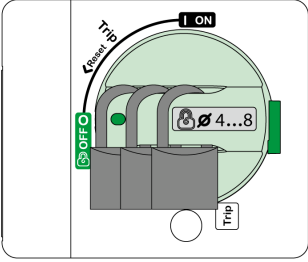
Lock position	Lock type	Lock characteristics	Lock image
O (OFF)	Standard padlocking	Up to 3 padlocks (not supplied) Diameter: 4–8 mm (3/16–5/16 in.)	
I (ON) or O (OFF)	Padlocking after modification of the rotary handle during installation	Up to 3 padlocks (not supplied) Diameter: 4–8 mm (3/16–5/16 in.)	
			

Inserting Padlocks in the Handle

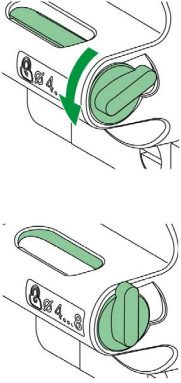
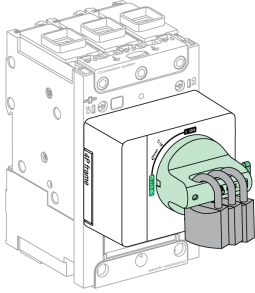
Step	Action	Comment
1	With the handle in the O (OFF) or I (ON) position, turn the knob as illustrated until the slot in the handle opens.	
2	Insert the padlocks in the slot.	

Overriding the Door Interlock

⚠ ⚠ DANGER

HAZARD OF ELECTRIC SHOCK, EXPLOSION, OR ARC FLASH

Overriding the door interlock must only be done by qualified electrical personnel.

Failure to follow these instructions will result in death or serious injury.

If it was activated at the time of installation, the interlock between the door and the circuit breaker allows you to open the door only when the circuit breaker is open and the rotary handle is in the **O (OFF)** position. When the rotary handle is in the **I (ON)** position or the **Trip** position, the door interlock prevents you from opening the door. To open the door, you must turn the handle to the **O (OFF)** position.

Under exceptional circumstances, qualified electrical personnel can follow these steps to open the door while the rotary handle is in the **I (ON)** position or the **Trip** position:

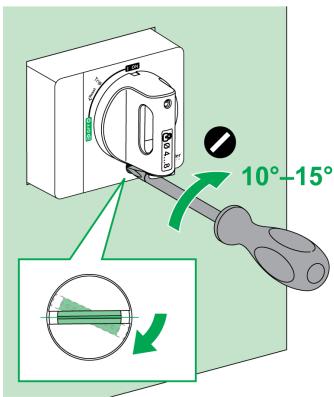
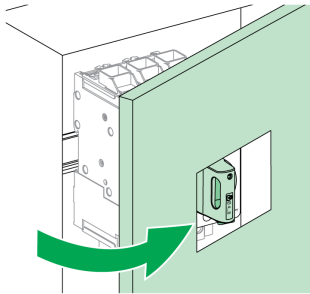
Step	Action	
1	Using a screwdriver, turn the locking screw clockwise by 10 to 15 degrees and then hold the screwdriver in place.	
2	Still holding the screwdriver in place, open the door and then release the locking screw.	

To close the door, use a screwdriver to turn the locking screw clockwise by 10 to 15 degrees. Holding the screwdriver in place, close the door and then release the locking screw.

Section 3.3

Operating a Circuit Breaker with a Front Extended Rotary Handle

What Is in This Section?

This section contains the following topics:

Topic	Page
Description	46
Opening, Closing, Resetting, and Testing the Circuit Breaker	47
Locking the Circuit Breaker	51

Description

Front Face

The controls, indicators, and locking mechanism are located on the following parts of the circuit breaker:

- The operating control is on the enclosure door.
- The operation indicators are on the circuit breaker and on the door plate.
- The locking mechanism is on the circuit breaker (door open) or on the door plate (door closed).

To operate the circuit breaker when the door is open, use an open door shaft operator, available as an accessory.

The following figures show the controls and indicators for a circuit breaker with a front extended rotary handle. Information about the other parts of the front face is available in the general description (*see page 11*).

Cabinet door open

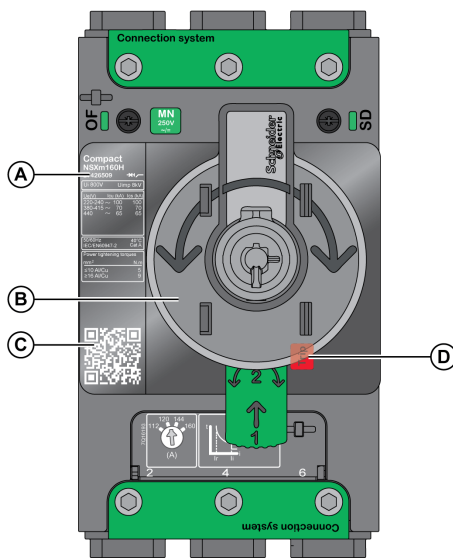

Cabinet door closed

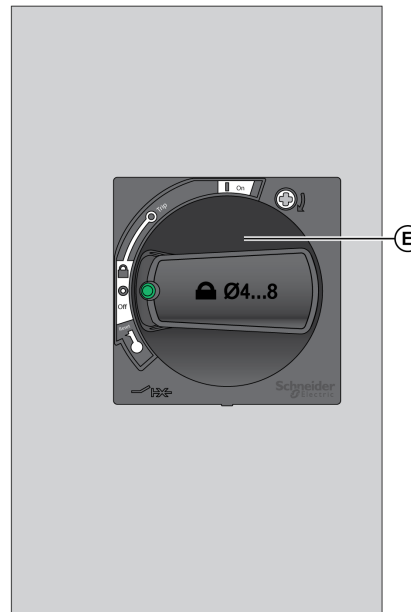

- A Device identification
- B Open door shaft operator
- C QR code
- D Push-to-trip button

- E Door operator

Device Identification

Information about the circuit breaker is given on the device identification label (*see page 38*).

QR Code

Scan the QR code to get additional information about the circuit breaker from the Schneider Electric website. To scan the QR code, use a smartphone that is equipped with a camera and installed with a QR code reader.

Opening, Closing, Resetting, and Testing the Circuit Breaker

Opening and Closing with the Front Extended Rotary Handle

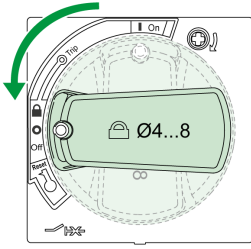
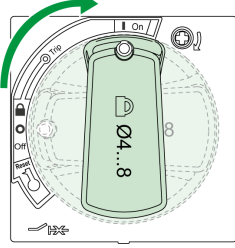
Task	Action	
Open the circuit breaker	Turn the rotary handle from the I (ON) position to the O (OFF) position.	
Close the circuit breaker	Turn the rotary handle from the O (OFF) position to the I (ON) position.	

Resetting the Front Extended Rotary Handle After a Trip

When the circuit breaker trips, the rotary handle moves from the **I (ON)** position to the **Trip** position.

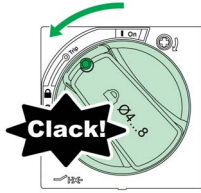

⚠ WARNING

HAZARD OF CLOSING ON ELECTRICAL FAULT

Do not close the circuit breaker again without first inspecting and, if necessary, repairing the downstream electrical equipment.

Failure to follow these instructions can result in death, serious injury, or equipment damage.

The fact that a circuit breaker has tripped does not fix the cause of the fault detected on the downstream electrical equipment.

Follow these steps to reset the circuit breaker after a trip caused by an electrical fault.

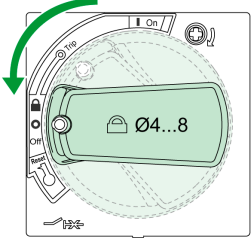
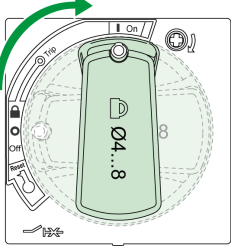
Step	Action		Position
1	Turn the handle from the Trip position to the O (OFF) position. The circuit breaker is open.		O (OFF)
2	Take precautions to protect yourself (<i>see page 78</i>).	–	O (OFF)
3	Look for the cause of the detected fault (<i>see page 78</i>).	–	O (OFF)
4	Clean and test the downstream equipment and the circuit breaker (<i>see page 78</i>).	–	O (OFF)
5	Turn the handle from the O (OFF) position to the I (ON) position. The circuit breaker is closed.		I (ON)

Testing the Trip Mechanism

⚠ CAUTION

HAZARD OF NUISANCE TRIPPING

Circuit breaker tests must only be done by qualified electrical personnel.

Failure to follow these instructions can result in injury or equipment damage.

When testing the trip mechanism take precautions against:

- Disrupting operations
- Activating inappropriate alarms
- Triggering unwanted actions

For example, tripping the circuit breaker with the push-to-trip button can lead to inappropriate fault indications or corrective actions (such as switching to an alternate power source).

There is no push-to-trip button on the door of a circuit breaker with a front extended rotary handle. To check the trip mechanism, the door must first be opened.

Follow these steps to test the trip mechanism.

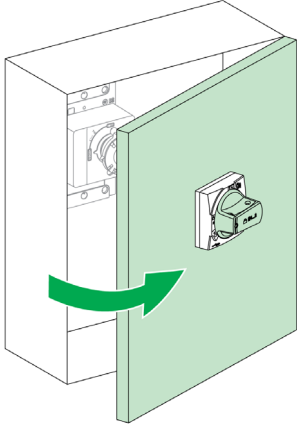
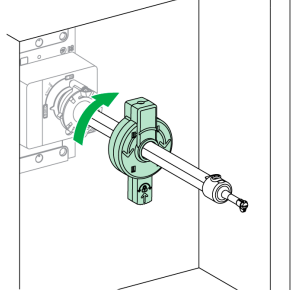
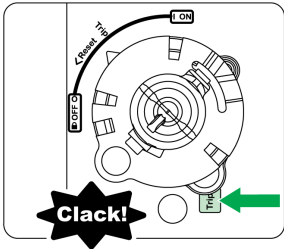
Step	Action		Position
1	With the circuit breaker in the O (OFF) position, open the door.		O (OFF)
2	Turn the circuit breaker from the O (OFF) position to the I (ON) position, using one of the following tools: <ul style="list-style-type: none"> • An open door shaft operator (LV426937). • A flat wrench, taking care not to damage the extension shaft or its surface treatment. The extension shaft is a hollow rectangular tube, 15 x 10 mm (0.59 x 0.39 in.). The circuit breaker is ready for the test.		I (ON)
3	Press the push-to-trip button. The circuit breaker trips.		Trip

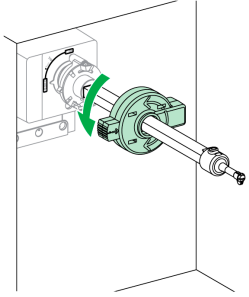
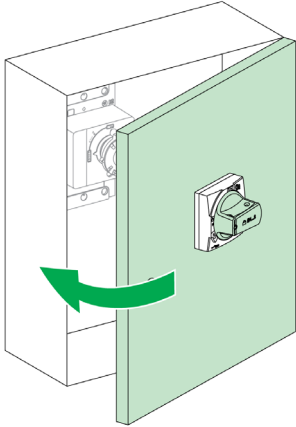
Step	Action		Position
4	Turn the circuit breaker from the Trip position to the O (OFF) position. The circuit breaker is open.		O (OFF)
5	Close the door.		-

Locking the Circuit Breaker

Locking Options for the Front Extended Rotary Handle

⚡ ⚠ DANGER

HAZARD OF ELECTRIC SHOCK, EXPLOSION, OR ARC FLASH

When the circuit breaker handle is locked in the **OFF (O)** position, always use a properly rated voltage sensing device to confirm that power is off before working on equipment.

Failure to follow these instructions will result in death or serious injury.

The extended rotary handle offers the following locking options:

- Prevent the door from being opened
- Prevent the rotary handle from being operated
- Prevent the circuit breaker itself from being operated

The handle can be locked in the **O (OFF)** position or, in the case of the black door operator, in the **I (ON)** position.

No setup is required to lock the handle in the **O (OFF)** position.

Before the handle can be locked in the **I (ON)** position, the door operator must be dismantled and the physical setup of the handle must be changed. This is usually done at installation. For information about how to set up the handle to be locked in the **I (ON)** position, see the relevant instruction sheet ([see page 7](#)).

NOTE: Locking the rotary handle in the **I (ON)** position does not disable the circuit breaker. If there is a fault detection, the circuit breaker still trips. When the rotary handle is unlocked, it moves to the **Trip** position.

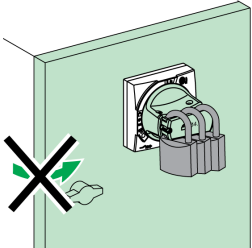
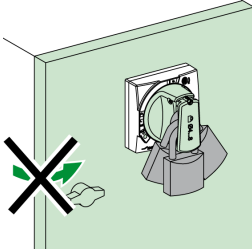
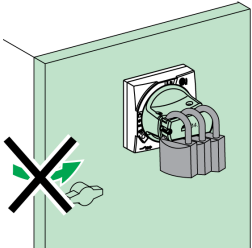
Lock position	Lock type	Lock characteristics	Lock image
O (OFF)	Standard padlocking	Up to 3 padlocks (not supplied) Diameter: 4–8 mm (3/16–5/16 in.)	
I (ON) or O (OFF) (Black door operator only)	Padlocking after modification of the door operator during installation	Up to 3 padlocks (not supplied) Diameter: 4–8 mm (3/16–5/16 in.)	
			

Inserting Padlocks in the Handle

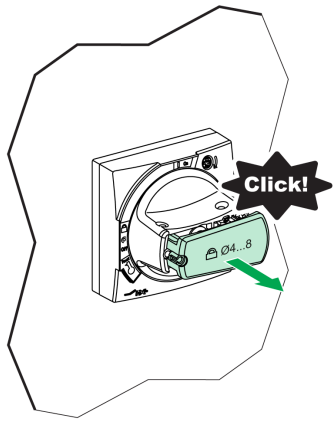
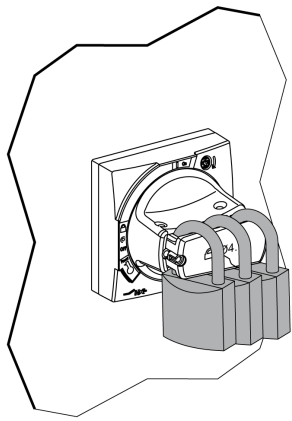
Step	Action	Comment
1	With the handle in the O (OFF) or I (ON) position, pull the cover on the front of the handle until you hear a click. A space opens between the handle and the cover.	
2	Insert the padlocks in the space.	

Locking the Circuit Breaker in the O (OFF) Position When the Door Is Open

The following procedure explains how to lock the circuit breaker itself, instead of the handle.

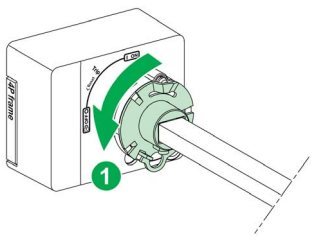
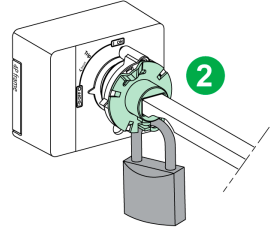
Step	Action	Comment
1	With the circuit breaker in the O (OFF) position, turn the locking plate anti-clockwise by 60 degrees to align the holes for the lock.	
2	Put a padlock or safety lockout hasp (4–8 mm, 3/16–5/16 in.) in the hole to lock the circuit breaker in the O (OFF) position.	

Overriding the Door Interlock

DANGER

HAZARD OF ELECTRIC SHOCK, EXPLOSION, OR ARC FLASH

Overriding the door interlock must only be done by qualified electrical personnel.

Failure to follow these instructions will result in death or serious injury.

An interlock between the door and the circuit breaker position allows you to open the door only when the circuit breaker is open and the rotary handle is in the **O (OFF)** position.

When the rotary handle is in the **I (ON)** position or the **Trip** position, the door interlock prevents you from opening the door. To open the door, you must turn the handle to the **O (OFF)** position.

Under exceptional circumstances, qualified electrical personnel can follow these steps to open the door while the rotary handle is in the **I (ON)** position or the **Trip** position:

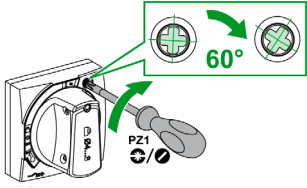
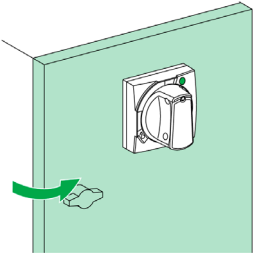
Step	Action	
1	Using a screwdriver, turn the locking screw clockwise by 60 degrees and hold the screwdriver in place.	
2	Open the door.	

To close the door, use a screwdriver to turn the locking screw clockwise by 60 degrees. Holding the screwdriver in place, close the door and then release the locking screw.

Section 3.4

Operating a Circuit Breaker with a Side Rotary Handle

What Is in This Section?

This section contains the following topics:

Topic	Page
Description	55
Opening, Closing, Resetting, and Testing the Circuit Breaker	56
Locking the Circuit Breaker	59

Description

Front Face

The controls, indicators, and locking mechanism are located on the following parts of the circuit breaker:

- The operating control is on the side plate.
- The operation indicators are on the circuit breaker and on the side plate.
- The locking mechanism is on the side plate.

The following figure shows the controls and indicators for a circuit breaker with a side rotary handle. Information about the other parts of the front face is available in the general description (*see page 11*).

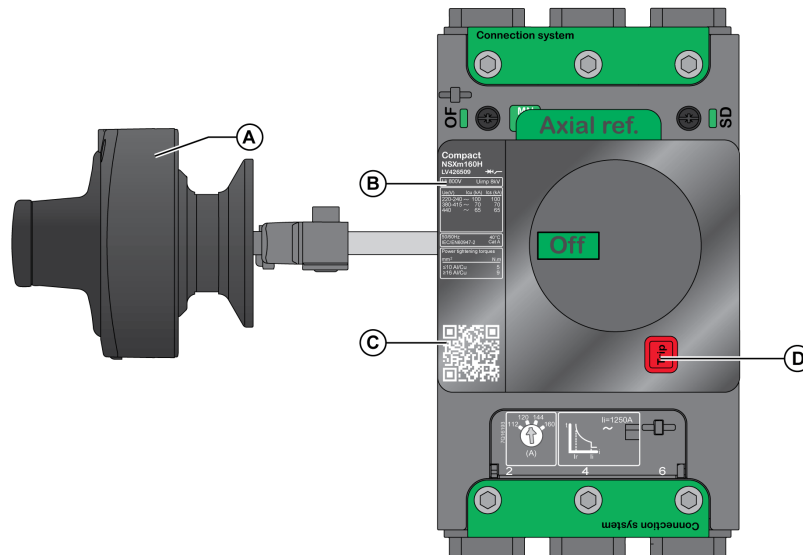

- A Side rotary handle
- B Device identification
- C QR code
- D Push-to-trip button

Device Identification

Information about the circuit breaker is given on the device identification label (*see page 38*).

QR Code

Scan the QR code to get additional information about the circuit breaker from the Schneider Electric website. To scan the QR code, use a smartphone that is equipped with a camera and installed with a QR code reader.

Opening, Closing, Resetting, and Testing the Circuit Breaker

Opening and Closing with the Side Rotary Handle

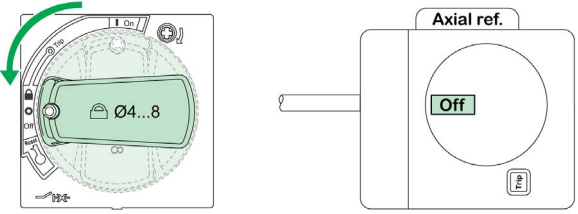
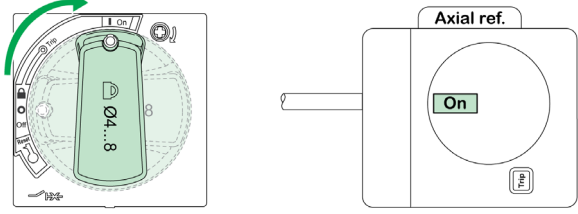
Task	Action
<p>To open the circuit breaker, turn the rotary handle from the I (ON) position to the O (OFF) position.</p>	
<p>To close the circuit breaker, turn the rotary handle from the O (OFF) position to the I (ON) position.</p>	

Resetting with a Side Rotary Handle After a Trip

When the circuit breaker trips, the rotary handle moves from the **I (ON)** position to the **Trip** position.

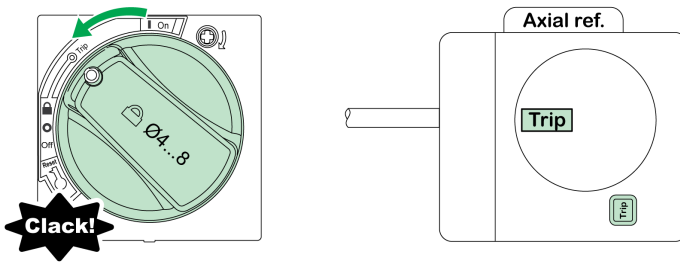

After a trip, reset a circuit breaker with a side rotary handle in the same way as for a circuit breaker with an extended rotary handle ([see page 48](#)).

Testing the Trip Mechanism

⚠ CAUTION

HAZARD OF NUISANCE TRIPPING

Circuit breaker tests must only be done by qualified electrical personnel.

Failure to follow these instructions can result in injury or equipment damage.

When testing the trip mechanism take precautions against:

- Disrupting operations
- Activating inappropriate alarms
- Triggering unwanted actions

For example, tripping the circuit breaker with the push-to-trip button can lead to inappropriate fault indications or corrective actions (such as switching to an alternate power source).

There is no push-to-trip button on the door of a circuit breaker with a side rotary handle. To check the trip mechanism, the door must first be opened.

Follow these steps to test the trip mechanism.

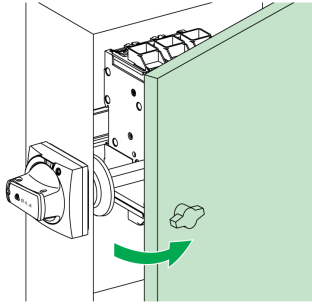
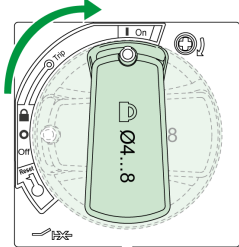
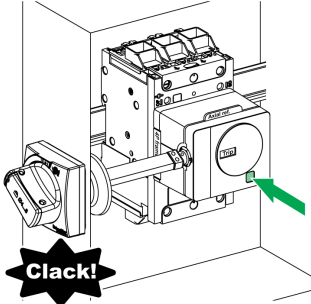
Step	Action		Position
1	With the circuit breaker in the O (OFF) position, open the enclosure door.		O (OFF)
2	Turn the circuit breaker from the O (OFF) position to the I (ON) position. The circuit breaker is ready for the test.		I (ON)
3	Press the push-to-trip button. The circuit breaker trips.		Trip

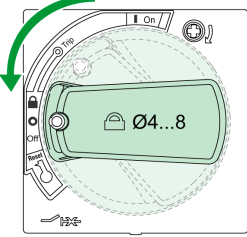
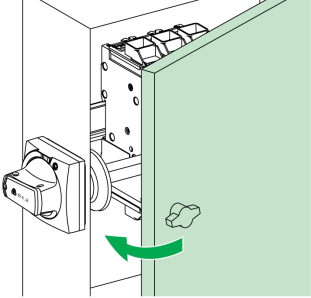
Step	Action		Position
4	Turn the circuit breaker from the Trip position to the O (OFF) position. The circuit breaker is open.		O (OFF)
5	Close the door.		-

Locking the Circuit Breaker

Locking Options with a Side Rotary Handle

DANGER

HAZARD OF ELECTRIC SHOCK, EXPLOSION, OR ARC FLASH

When the circuit breaker handle is locked in the **OFF (O)** position, always use a properly rated voltage sensing device to confirm that power is off before working on equipment.

Failure to follow these instructions will result in death or serious injury.

The side rotary handle offers a locking option to prevent the rotary handle from being operated.

The handle can be locked in the **O (OFF)** position or, in the case of the black side operator, in the **I (ON)** position.

No setup is required to lock the handle in the **O (OFF)** position.

Before the handle can be locked in the **I (ON)** position, the side operator must be dismantled and the physical setup of the handle must be changed. This is usually done at installation. For information about how to set up the handle to be locked in the **I (ON)**, position, see the relevant instruction sheet (*see page 7*).

NOTE: Locking the rotary handle in the **I (ON)** position does not disable the circuit breaker. If there is a fault detection, the circuit breaker still trips. When the rotary handle is unlocked, it moves to the **Trip** position.

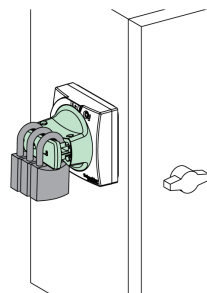
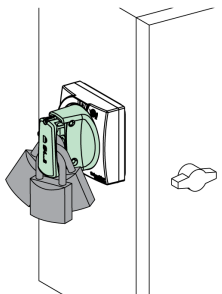
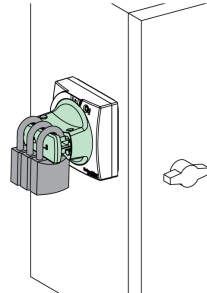
Lock position	Lock type	Lock characteristics	Lock image
O (OFF)	Standard padlocking	Up to 3 padlocks (not supplied) Diameter: 4–8 mm (3/16–5/16 in.)	
I (ON) or O (OFF) (Black side operator only)	Padlocking after modification of the side operator during installation	Up to 3 padlocks (not supplied) Diameter: 4–8 mm (3/16–5/16 in.)	 

Inserting Padlocks in the Handle

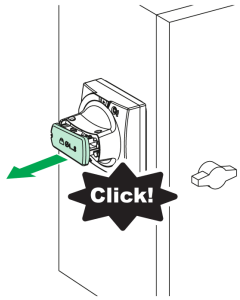
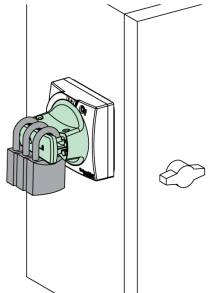
Step	Action	Comment
1	<p>With the handle in the O (OFF) or I (ON) position, pull the cover on the front of the handle until you hear a click. A space opens between the handle and the cover.</p>	
2	<p>Insert the padlocks in the space.</p>	

Chapter 4

Electrical Auxiliary Devices

What Is in This Chapter?

This chapter contains the following topics:

Topic	Page
Electrical Auxiliary Devices	62
Indication Contacts	64
Voltage Releases	65
SDx Module	66

Electrical Auxiliary Devices

Summary of Electrical Auxiliary Devices

The following table shows electrical auxiliary devices that can be added to circuit breakers. Auxiliary contacts can be installed on site. For more information, see the *Compact NSXm Catalog*.

Electrical auxiliary device	Use	3P/4P circuit breaker	3P/4P ELCB
OF auxiliary contact	View the on/off status of the circuit breaker remotely.	✓	✓
SD auxiliary contact	View the trip status of the circuit breaker remotely.	✓	✓
MX shunt trip	Send an electrical trip command remotely.	✓	✓
MN undervoltage release	Trip the circuit breaker when the control voltage drops below a tripping threshold.	✓	✓
MN undervoltage release with time-delay unit	Intended to avoid nuisance tripping in systems with frequent voltage dips lasting from 200 ms to 3 s.	✓	✓
SDx module	Provide alarm and fault differentiation for the Compact NSXm earth-leakage circuit breaker.	–	✓

Slots for Electrical Auxiliary Devices for Circuit Breaker

The following figures show the available slots for electrical auxiliary devices mounted in the circuit breaker case. One auxiliary can be installed in each slot. For more information, see the *Compact NSXm Catalog*.

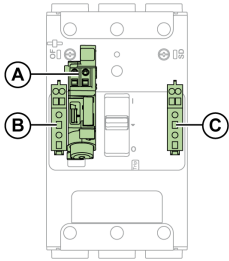
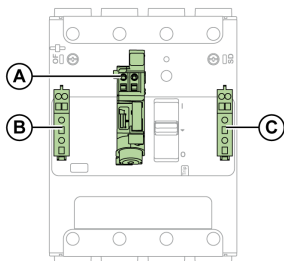
3P circuit breaker	4P circuit breaker
	
<p>A MN undervoltage release or MX shunt trip B OF auxiliary contact C SD auxiliary contact</p>	

Slots for Electrical Auxiliary Devices for Earth-Leakage Circuit Breaker

The following figures show the available slots for electrical auxiliary devices mounted in the case of the earth-leakage circuit breaker (ELCB). One auxiliary can be installed in each slot.

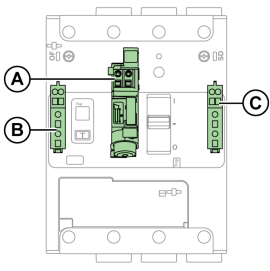
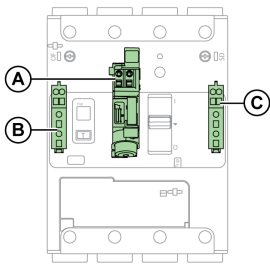
3P ELCB	4P ELCB
	
<p>A MN undervoltage release or MX shunt trip B OF auxiliary contact C SD auxiliary contact</p>	

The following figures show the available slots for electrical auxiliary devices mounted outside the earth-leakage circuit breaker (ELCB). Two SDx modules can be installed.

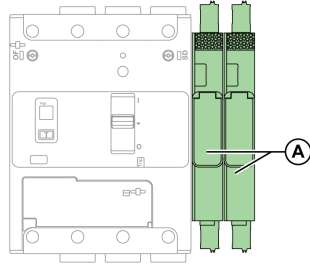
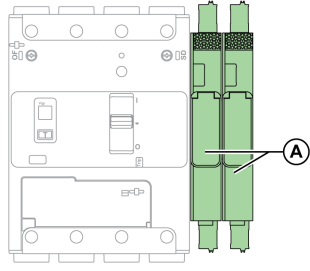
3P ELCB	4P ELCB
	
<p>A SDx module (1 or 2 maximum)</p>	

For more information, see the *Compact NSXm Catalog*.

Indication Contacts

Characteristics of Indication Contacts

Use indication contacts to view the status of the circuit breaker remotely.

Indication contacts are located under the front face of the circuit breaker, in a compartment that is isolated from the power circuits. When an indication contact is present, a green flag is displayed on the front of the circuit breaker.

The contacts used for indication contacts are common point changeover contacts.

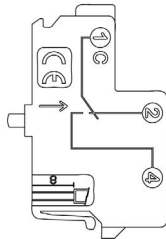

C(1) Common

NC(2) Normally closed contact. The NC contact is normally closed when the circuit breaker is in the **O (OFF)** position.

NO(4) Normally open contact. The NO contact is normally open when the circuit breaker is in the **O (OFF)** position.

NOTE: The indication contact provides either OF or SD indication functions, depending on its location in the circuit breaker.

Name	Definition
OF open / close indication contact	The OF contact indicates the state of the circuit breaker, (I (ON) or O (OFF)/Trip). Changeover <ul style="list-style-type: none"> • O (OFF) to I (ON) • I (ON) to O (OFF) • I (ON) to Trip
SD trip indication contact	The SD contact indicates that the circuit breaker has tripped due to: <ul style="list-style-type: none"> • Operation of the push-to-trip button • Operation of the MX shunt trip or MN undervoltage release • Electrical fault detected by the protection Changeover <ul style="list-style-type: none"> • I (ON) to Trip • Trip to O (OFF)

Operation of the Indication Contacts

The following figures show the position of the indication contacts for each position of the handle and main contacts.

Name	Contact number	Position of the handle and contacts		
Device status	-	OFF	ON	Tripped (by MN/MX, push-to-trip, or protection)
Handle position	-			
Main contact position	-	Open	Closed	Open
OF auxiliary contact position	1-2	Closed	Open	Closed
	1-4	Open	Closed	Open
SD auxiliary contact position	1-2	Closed	Closed	Open
	1-4	Open	Open	Closed

Voltage Releases

Characteristics

The following voltage release auxiliaries are operated remotely by an electrical trip command:

- MX shunt trip
- MN undervoltage release
- MN undervoltage release with time-delay unit. The time-delay unit helps to overcome nuisance tripping due to transient voltage dips. The time delay is adjustable up to three seconds.

NOTE: It is recommended to test the operation of a voltage release at regular intervals, such as every six months.

Voltage release auxiliaries are installed in the case under the front face of the circuit breaker. The presence and characteristics of a voltage release auxiliary are displayed through a window on the front face.

The characteristics of voltage release auxiliaries comply with IEC/EN 60947-2 recommendations.

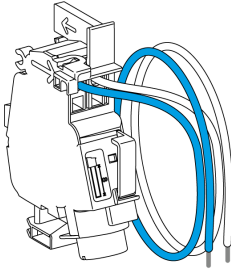
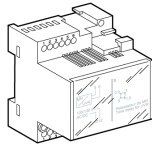
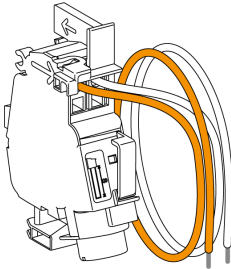
Name	Image	Description
MN undervoltage release		<ul style="list-style-type: none"> ● Trips the circuit breaker when the voltage is less than 0.35 times the rated voltage (U_n). <ul style="list-style-type: none"> ○ If the voltage is between 0.35 and 0.7 times the rated voltage (U_n), tripping can occur but is not certain to occur. ○ If the voltage is above 0.7 times the rated voltage (U_n), tripping cannot occur. ● Allows the circuit breaker to be closed again when the voltage reaches 0.85 times the rated voltage (U_n). <p>Use this type of accessory for failsafe emergency stops.</p>
Time-delay unit for MN undervoltage release		<p>Removes nuisance tripping of an undervoltage release by setting a time delay of up to 3 s to overcome transient voltage dips. Adjustable and fixed time-delay units are available.</p>
MX shunt trip		<p>Trips the circuit breaker when the voltage exceeds 0.7 times the rated voltage (U_n).</p> <p>NOTE: MX shunt trip 110/130 Vac combined with Class I ground-fault sensing element is suitable for ground-fault protection. In this application, the circuit breaker trips when the voltage exceeds 0.55 times the rated voltage (U_n).</p>

SDx Module

Introduction

One or two optional SDx modules can be installed on an earth-leakage circuit breaker (ELCB). The SDx module has two outputs and provides alarms and fault differentiation.

The SDx module receives data from the trip unit through an optical link.

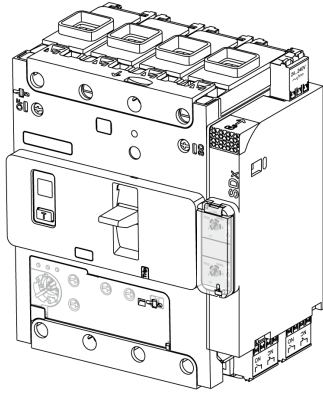

Description

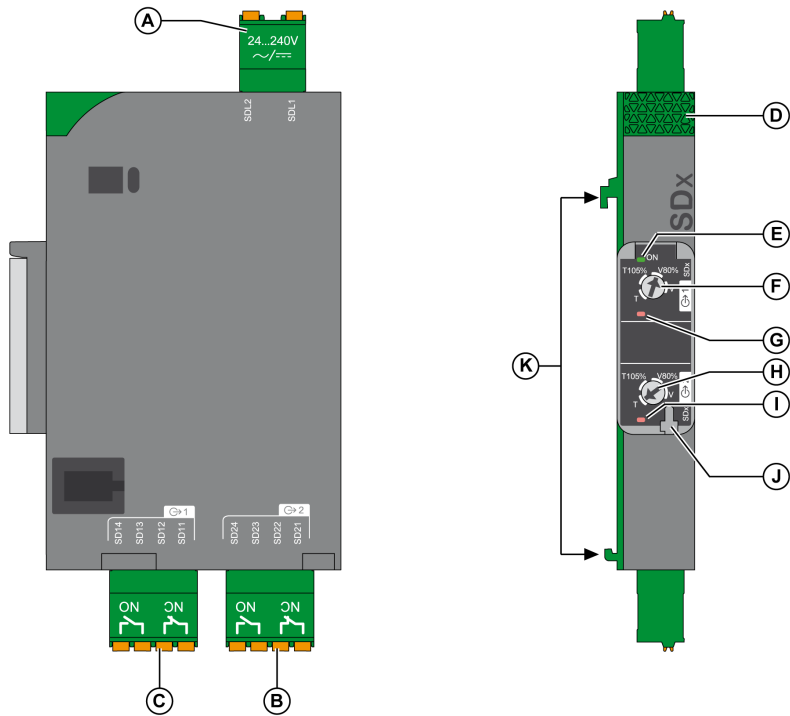

- A** Power supply
- B** Output 2 (1NO+1NC)
- C** Output 1 (1NO+1NC)

- D** Lock knob
- E** SDx module status
 - OFF: SDx module not powered
 - Green: SDx module powered
- F** Output 1 setting dial
- G** Output 1 status LED
 - OFF: output de-activated
 - Red: output activated
- H** Output 2 setting dial
- I** Output 2 status LED
 - OFF: output de-activated
 - Red: output activated
- J** Seal for setting cover
- K** Clips to attach to ELCB

SDx Module Characteristics

Power supply: 24–240 Vac/Vdc

Power:

- 2,000 VA maximum
- 240 W maximum

Output characteristics:

- Voltage: 24–250 Vac/Vdc
- Current: 2 mA–5 A maximum

Output Settings

The function assigned to each output of the SDx module is set by using a setting dial. Each output can be assigned with one of the following indications:

- Overload trip indication (SDT): circuit breaker has tripped due to an overload fault.
- Overload alarm (SDT105%): current is higher than 105% of the setting current (I_r).
- Earth-leakage alarm (SDV80%): leakage current is higher than 80% of the earth-leakage trip threshold ($I_{\Delta n}$).
- Earth-leakage trip indication (SDV): circuit has tripped due to an earth-leakage current.

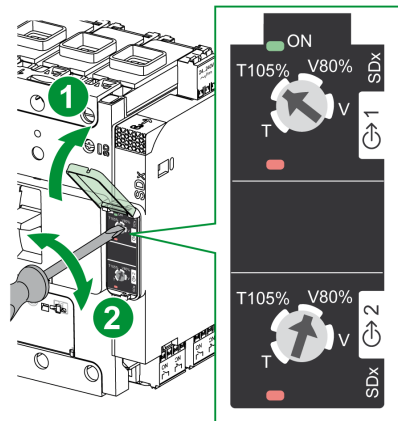

- T** SDT thermal fault indication
- T105%** SDT thermal alarm: 105% I_r
- V80%** SDV earth-leakage alarm: 80% $I_{\Delta n}$
- V** SDV earth-leakage fault indication

SDT and SDT105% Operating Modes

Operating modes of the SDT output:

- The output is activated when the circuit breaker trips due to an overload fault.
- The output is reset when the circuit breaker is reset, closed, and energized.

Operating modes of the SDT105% output:

- The output is activated when current is greater than $105\% \times I_r$.
- The output is reset in one of the following cases:
 - The current is lower than $105\% \times I_r$.
 - After tripping, the circuit breaker is reset, closed, and energized.

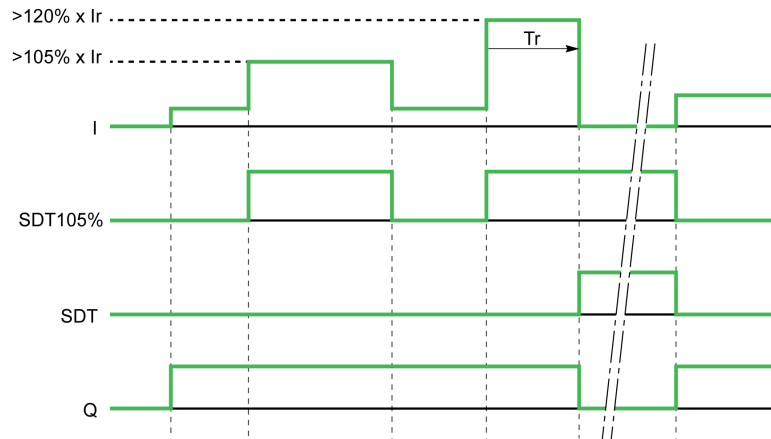

I	Charge current
SDT105%	Thermal alarm
SDT	Thermal fault indication
Q	Circuit breaker

SDV and SDV80% Operating Modes

Operating modes of the SDV output:

- The output is activated when the circuit breaker trips due to an earth-leakage fault.
- The output is reset when the circuit breaker is reset, closed, and energized.

Operating modes of the SDV80% output:

- The output is activated when the earth-leakage current is greater than $80\% \times I_{\Delta n}$ for more than 5 seconds.
- The output is reset in one of the following cases:
 - The current is lower than $80\% \times I_{\Delta n}$.
 - After tripping, the circuit breaker is reset, closed, and energized.

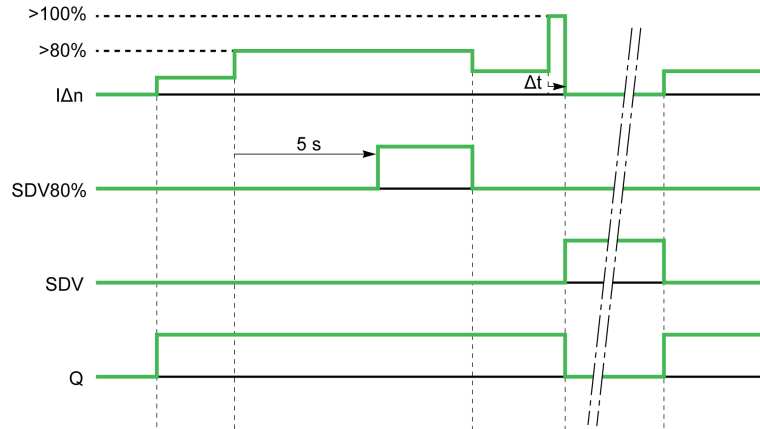

$I_{\Delta n}$	Earth-leakage current
SDV80%	Earth-leakage alarm
SDV	Earth-leakage fault indication
Q	Circuit breaker

Chapter 5

Commissioning and Maintenance

What Is in This Chapter?

This chapter contains the following topics:

Topic	Page
Commissioning the Circuit Breaker	72
Maintaining the Circuit Breaker During Operation	76
Responding to a Trip	78
Troubleshooting	80

Commissioning the Circuit Breaker

List of Checks and Inspections

DANGER

HAZARD OF ELECTRIC SHOCK, EXPLOSION, OR ARC FLASH

- Apply appropriate personal protective equipment (PPE) and follow safe electrical work practices. See NFPA 70E, CSA Z462, NOM-029-STPS, or local equivalent.
- This equipment must only be installed and serviced by qualified electrical personnel.
- Turn off all power supplying this equipment before working on or inside equipment.
- Always use a properly rated voltage sensing device to confirm that power is off.
- Replace all devices, doors, and covers before turning on power to this equipment.
- Beware of potential hazards, and carefully inspect the work area for tools and objects that may have been left inside the equipment.

Failure to follow these instructions will result in death or serious injury.

When equipment is commissioned or returned to service after a lengthy downtime, perform a general check on the equipment.

The following table summarizes when to carry out checks or inspections:

When to carry out the check or inspection	A	B	C	D	E	F	G	H
Before commissioning new equipment	✓	✓	✓	✓	✓	✓	✓	✓
Periodically during operation (<i>see page 76</i>)	✓	–	–	–	✓	✓	✓	✓
After carrying out work on the switchboard	–	–	✓	✓	✓	✓	✓	✓
Periodically during lengthy downtime	–	–	✓	–	✓	–	✓	✓
After a lengthy downtime	–	–	✓	–	✓	✓	✓	✓
After a lengthy downtime and modification to the switchboard	✓	✓	✓	✓	✓	✓	✓	✓
A Carry out insulation tests and dielectric strength tests B Carry out temperature rise tests C Inspect switchboard D Check compliance with the diagram E Inspect mechanical equipment F Check mechanical operation G Check earth-leakage protection (for earth-leakage circuit breaker only) H Clean equipment								

A: Insulation Tests and Dielectric Strength Tests

⚠ ⚠ DANGER

HAZARD OF ELECTRIC SHOCK, EXPLOSION, OR ARC FLASH

- Apply appropriate personal protective equipment (PPE) and follow safe electrical work practices.
- Insulation and dielectric strength tests must only be carried out by qualified electrical personnel.
- Disconnect all power sources before performing maintenance inspections.
Assume that all circuits are live until they are de-energized, tested, grounded, and tagged. Consider all sources of power, including the possibility of backfeeding and control power.
- Always use a properly rated voltage sensing device to confirm that power is off.
- Replace all devices, doors, and covers before turning on power to this equipment.
- The protective cover for the connections must be reconnected without fail following dielectric tests.

Failure to follow these instructions will result in death or serious injury.

Insulation tests and dielectric strength tests are done before the switchboard is delivered. These tests are compliant with the currently applicable standards.

Dielectric strength tests impose great stress on the equipment and can cause damage if performed incorrectly. In particular:

- Reduce the value used for the test voltage depending on the number of consecutive tests on the same piece of equipment.
- Disconnect electronic equipment if necessary.

For earth-leakage circuit breakers (ELCB):

NOTICE

HAZARD OF TRIP UNIT DETERIORATION

- Turn the dielectric switch to the **Test** position (horizontal) when performing a dielectric test.
- Turn the switch back to the original position after the dielectric test.
- Do not close the protective cover during the dielectric test.

Failure to follow these instructions can result in equipment damage.

To perform a dielectric test for earth-leakage circuit breaker, do the following procedure:

Step	Action	
1	Unclip the green protective cover at the bottom front face of the earth-leakage circuit breaker: Push the tip of the screwdriver to the back to release the clip.	
2	Remove the protective cover.	
3	Put the protective cover on one side.	
4	Turn the dielectric switch (A) counterclockwise from the RUN position (vertical) to the Test position (horizontal) by using a flat screwdriver. Result: The switch pops out when the screwdriver is removed.	
5	After carrying out a dielectric test, push in the switch...	
6	... and turn it clockwise from the Test position to the RUN position (vertical). Result: The dial stays pushed in (B) when the screwdriver is removed.	

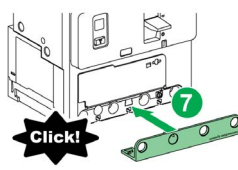
Step	Action	
7	Clip the green protective cover back into place.	
8	After performing the dielectric test, carry out an earth-leakage test (see page 19).	–

⚠ WARNING

LOSS OF EARTH-LEAKAGE PROTECTION

The dielectric switch must be in the retracted position while the circuit breaker is in use.

Failure to follow these instructions can result in death, serious injury, or equipment damage.

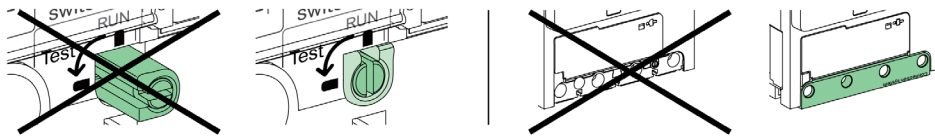

B: Temperature Rise Tests

Temperature rise tests are done before the switchboard is delivered. Compact NSXm circuit breakers comply with product standards IEC/EN 60947-1 and IEC/EN 60947-2.

For general-purpose systems, tests are carried out at an ambient temperature of 40 °C (104 °F). Above 40 °C (104 °F), thermal protection characteristics are slightly modified and the values defined in the derating tables must be taken into account. These values are valid for circuit breakers with or without terminal shields.

C: Inspect Switchboard

Check that the circuit breakers are installed:

- In a clean environment, without waste from assembling the equipment (such as wiring, tools, shavings, metallic particles).
- In a properly ventilated switchboard (unobstructed ventilation grills).

D: Check Compliance with the Diagram

Check that the circuit breakers comply with the installation diagram:

- Identification of the feeds on the front of the circuit breakers
- Rating and breaking capacity (shown on the device identification label)
- Identification of the trip unit (type, rating)
- Presence of additional functions (rotary handle, control, or indication auxiliaries, locking, sealing)
- Protection settings: visually check the position of the switches on the trip unit

E: Inspect Mechanical Equipment

Visually inspect the general state of the circuit breakers: terminal shields and interphase barriers, case, and connections.

Check the equipment integrity: a circuit breaker found with a cracked case or burn marks must be immediately taken out of service and replaced.

Check the mounting and mechanical strength of the following equipment:

- Circuit breakers in the switchboard, power connections
- Auxiliaries and accessories on the circuit breakers:
 - Rotary handles
 - Installation accessories, such as terminal shields and interphase barriers
 - Auxiliary circuit connections
- Locks, padlocks, and padlock support tabs

F: Check Mechanical Operation

Check the mechanical operation of the circuit breaker:

- Opening
- Closing
- Tripping with the push-to-trip button
- Resetting

G: Check Earth-Leakage Protection (For Earth-Leakage Circuit Breaker Only)

Check that the earth-leakage protection is working correctly by operating the test button **T** on the front (*see page 19*). This test checks the whole measurement system and tripping on earth-leakage faults.

H: Clean Equipment

To reduce dust deposits that can affect the mechanical operation of circuit breakers, clean the circuit breakers when performing maintenance:

- Non-metallic parts: Always use a dry cloth. Do not use cleaning products.
- Metallic parts: Preferably use a dry cloth. If a cleaning product is used, do not apply or splash the cleaning product on non-metallic parts.

Maintaining the Circuit Breaker During Operation

Introduction

DANGER

HAZARD OF ELECTRIC SHOCK, EXPLOSION, OR ARC FLASH

- Apply appropriate personal protective equipment (PPE) and follow safe electrical work practices. See NFPA 70E, CSA Z462, NOM-029-STPS, or local equivalent.
- This equipment must only be installed and serviced by qualified electrical personnel.
- Turn off all power supplying this equipment before working on or inside equipment.
- Always use a properly rated voltage sensing device to confirm that power is off.
- Replace all devices, doors, and covers before turning on power to this equipment.
- Beware of potential hazards, and carefully inspect the work area for tools and objects that may have been left inside the equipment.

Failure to follow these instructions will result in death or serious injury.

Like most equipment, electrical switchboards age whether they are being used or not. Aging is mostly caused by environmental influences and operating conditions.

To help circuit breakers keep the operating and safety characteristics specified in the catalog for the whole of their service life:

- Install circuit breakers in optimum environmental and operating conditions (described in the following table).
- Make sure that maintenance operations are carried out by qualified electrical personnel.

Environmental and Operating Conditions

The following table describes optimum environmental and operating conditions.

Environmental and operating factor	Optimum conditions
Temperature	Average annual temperature outside the switchboard is < 25 °C (77 °F).
Loading	Loading is < 80% of In for 24 hours a day.
Harmonics	Harmonic current per phase is < 30% of In.
Humidity	Relative humidity is < 70%.
Corrosive atmosphere (SO ₂ , NH ₃ , H ₂ S, Cl ₂ , NO ₂)	The circuit breaker is installed in environmental category 3C1 or 3C2 (IEC/EN 60721-3-3).
Saline environment	The circuit breaker is installed in an environment free of salt mist.
Dust	The dust level is low. If necessary, the circuit breaker is in a switchboard that is fitted with filters or is IP54 ventilated.
Vibration	Continuous vibration is < 0.2 g.

Maintenance programs apply to optimum environmental and operating conditions. Outside these limits, circuit breakers are subject to accelerated aging, which can quickly lead to problems.

In harsh environmental and operating conditions, you must refer to the derating tables and reduce the maintenance intervals (*see page 21*).

Regular Preventive Maintenance

Maintenance recommendations for each product are intended to maintain the equipment or subassemblies in a satisfactory operational state for their useful service life.

The following table summarizes maintenance operations and intervals for the three preventive maintenance levels:

Maintenance interval	Maintenance operations	Performed by
1 year	Basic level tasks: visual inspection and functional testing, replacement of inoperative accessories.	<ul style="list-style-type: none"> • Qualified customer employee with basic training • Schneider Electric certified partner • Schneider Electric field service representative
2 years	Advanced level tasks: Basic level tasks, plus operational servicing and subassembly tests.	<ul style="list-style-type: none"> • Qualified technician with advanced training • Schneider Electric certified partner • Schneider Electric field service representative
5 years	Exclusive level tasks: Advanced level tasks, plus manufacturer diagnostics and part replacements by Schneider Electric Services.	<ul style="list-style-type: none"> • Schneider Electric field service representative

The maintenance intervals in the previous table are for normal environmental and operating conditions. If **all** environmental conditions are more favorable, maintenance intervals can be longer. For example, Advanced level tasks could be carried out every 3 years.

If any one of the conditions is more severe, perform maintenance more frequently. For advice, contact Schneider Electric Services.

Functions linked specifically to safety require particular maintenance intervals.

NOTE: Regularly test that the remote safety commands work. For example, test at least every six months.

Maintenance Operations Required

Maintenance operations mainly consist of checks and inspections A, E, F, and G, as defined for the commissioning phase (*see page 72*).

⚠ CAUTION
HAZARD OF EQUIPMENT DAMAGE
Insulation and dielectric strength tests must only be carried out by qualified electrical personnel.
Failure to follow these instructions can result in injury or equipment damage.

Maintenance operation	Year 1	Year 2	Year 3	Year 4	Year 5
Insulation and dielectric strength tests (A)	✓	✓	✓	✓	✓
Inspect mechanical equipment (E)	✓	✓	✓	✓	✓
Measurement of insulation resistance	–	–	–	–	✓
Check mechanical operation (F)	✓	✓	✓	✓	✓
Check the closing time, opening time, and voltage release characteristics	–	✓	–	✓	✓
Replace the MN undervoltage release	–	–	–	–	✓
Clean equipment (G)	✓	✓	✓	✓	✓

For a detailed definition of the maintenance operations, contact Schneider Electric Services.

Responding to a Trip

Taking Precautions Before Responding to a Trip

 DANGER
HAZARD OF ELECTRIC SHOCK, EXPLOSION, OR ARC FLASH
<ul style="list-style-type: none">● Apply appropriate personal protective equipment (PPE) and follow safe electrical work practices. See NFPA 70E, CSA Z462, NOM-029-STPS, or local equivalent.● This equipment must only be installed and serviced by qualified electrical personnel.● Turn off all power supplying this equipment before working on or inside equipment.● Always use a properly rated voltage sensing device to confirm that power is off.● Replace all devices, doors, and covers before turning on power to this equipment.● Beware of potential hazards, and carefully inspect the work area for tools and objects that may have been left inside the equipment.
Failure to follow these instructions will result in death or serious injury.

Before inspecting electrical equipment downstream of the circuit breaker, always isolate the feed.

Identifying the Cause of the Trip

A trip can be caused by the following events:

- Fault detection on the installation
- Fault detection caused by malfunction
- Intentional tripping

Check the circuit breaker and the electrical installation to find the root cause of the trip.

Checking Equipment After a Trip

 WARNING
HAZARD OF CLOSING ON ELECTRICAL FAULT
Do not close the circuit breaker again without first inspecting and, if necessary, repairing the downstream electrical equipment.
Failure to follow these instructions can result in death, serious injury, or equipment damage.

NOTE: Checks, tests, and inspections must be carried out by qualified electrical personnel.

The fact that the protection has tripped does not fix the cause of the fault detected on the downstream equipment.

Perform the following tasks after a short-circuit:

- Carefully clean off any traces of black smoke. The smoke particles can conduct electricity.
- Check the power connections and control wires.
- Operate the circuit breaker at least five times at zero load.

Depending on the type of fault detected, perform the following inspections on all or part of the equipment where the fault occurred (*see page 72*):

- For faults tripped by thermal protection:
 - Check the system for damage, and then repair if necessary.
 - Perform checks E and F.
- For faults tripped by magnetic protection or caused by an unknown reason:
 - Check the system for damage, and then repair if necessary.
 - Perform checks A, E, and F.
- For faults tripped by earth-leakage protection:
 - Check the system for damage, and then repair if necessary.
 - Perform checks E, F, and G.

Resetting the Circuit Breaker

Before resetting the circuit breaker, make sure that the fault is identified and repaired, and that the installation has been checked.

If the system must be restarted quickly (for example, in a safety installation), isolate and lock out the affected part of the installation before carrying out maintenance.

The procedure for resetting a circuit breaker depends on the type of handle on the circuit breaker (*see page 31*).

Troubleshooting

Repetitive Tripping

Indication	Probable cause	Checks or repairs
SD	The voltage of the power supply to the MN undervoltage release is too low or subject to significant variations.	Check the power supply for the release. For example, a supply powering motors with high-power ratings can be unstable. If necessary, connect the release to a clean or stable supply.
	The power supply to an MX shunt trip is applied unintentionally.	Compare the release connection with the installation diagram to make sure that it is correct.
SD	Operating temperature too high.	Check the switchboard ventilation and the temperature in the room.
SDV	Inappropriate earth-leakage protection setting.	Check the value of the natural leakage current. Depending on the results: <ul style="list-style-type: none"> ● Isolate the equipment which had excessive natural leakage current. ● Raise the earth-leakage protection setting, observing the safety rules.
	Transient ground fault on the equipment.	Check whether the fault coincides with commissioning an item of equipment. Depending on the results: <ul style="list-style-type: none"> ● Repair the equipment causing the fault. ● Isolate the equipment which has excessive natural leakage current. ● Raise the earth-leakage protection setting, observing the safety rules.

Circuit Breaker Does Not Close

Indication	Probable cause	Checks or repairs
SD	MX shunt trip energized. MN undervoltage release not energized.	Compare the release connection with the installation diagram to make sure that it is correct.

Appendices



Appendix A

Wiring Diagrams

Circuit Breakers

Introduction

The diagrams are shown with circuits de-energized, all devices open, connected, and charged, and relays in normal position.

Terminals shown in red  must be connected by the customer.

Indication Contacts

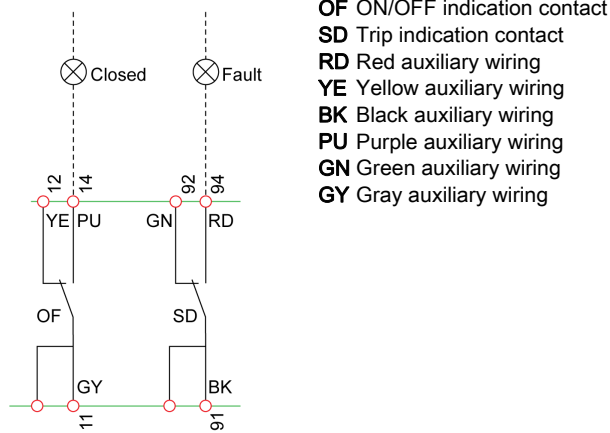

- OF** ON/OFF indication contact
- SD** Trip indication contact
- RD** Red auxiliary wiring
- YE** Yellow auxiliary wiring
- BK** Black auxiliary wiring
- PU** Purple auxiliary wiring
- GN** Green auxiliary wiring
- GY** Gray auxiliary wiring

Remote Operation

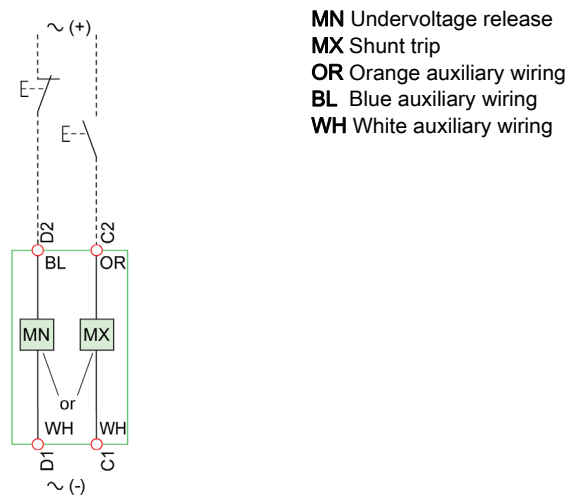

- MN** Undervoltage release
- MX** Shunt trip
- OR** Orange auxiliary wiring
- BL** Blue auxiliary wiring
- WH** White auxiliary wiring

SDx Module

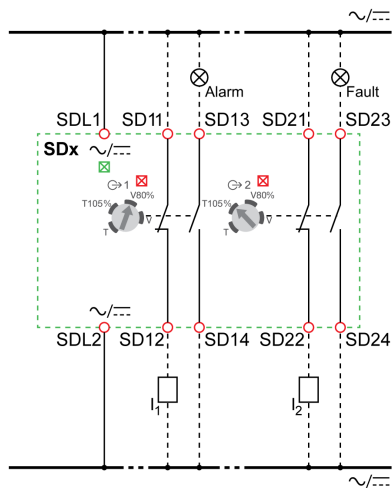

SDx SDx module
I1, I2 Digital inputs



A

- auxiliaries
 - voltage releases, *65*
- auxiliary contacts
 - operation, *64*
- auxiliary devices, *61*
- auxiliary slots, *62, 63*

C

- checks
 - commissioning, *72*
 - maintenance, *76*
- circuit breakers
 - auxiliary slots, *62*
 - close, *34, 39*
 - commissioning, *72*
 - commissioning and maintenance, *71*
 - description, *11*
 - features, *10*
 - locking, *36*
 - maintenance, *76*
 - open, *34, 39*
 - reset, *40, 48*
 - testing, *35, 41, 49, 57*
 - toggle handle, *33*
- close, *34, 39*
 - front extended rotary handle, *47*

E

- earth-leakage circuit breakers
 - auxiliary slots, *63*
 - description, *11*
 - trip unit, *15*
- electrical accessories, *25*

I

- indication contacts
 - auxiliary slots, *62, 63*
 - operation, *64*
- insulation accessories, *25*
- insulation requirements, *25*

L

- locking
 - circuit breakers, *36*

M

- MN
 - undervoltage release, *62, 65*
 - undervoltage release with time-delay unit, *62*
- MX
 - shunt trip, *62, 65*

O

- OF
 - auxiliary contact, *62*
 - open / close indication contact, *64*
- open, *34, 39*

P

- protection
 - magnetic, *20*
 - thermal-magnetic (TM-D), *14*
 - trip unit, *15*

R

- reset, *40, 48*

S

- SD
 - auxiliary contact, *62*
 - trip indication contact, *64*
- SDx module, *66*
- sealing accessories, *13*

T

- testing
 - circuit breakers, *35, 41, 49, 57*
 - trip mechanism, *35, 41, 49, 57*
- trip mechanism
 - testing, *35, 41, 49, 57*

V

- voltage releases, *65*



DOCA0096EN-01

Schneider Electric Industries SAS

35, rue Joseph Monier
CS30323
F - 92506 Rueil Malmaison Cedex

<http://www.schneider-electric.com>

As standards, specifications and designs change from time to time, please ask for confirmation of the information given in this publication.